

Forum

2nd

Floor

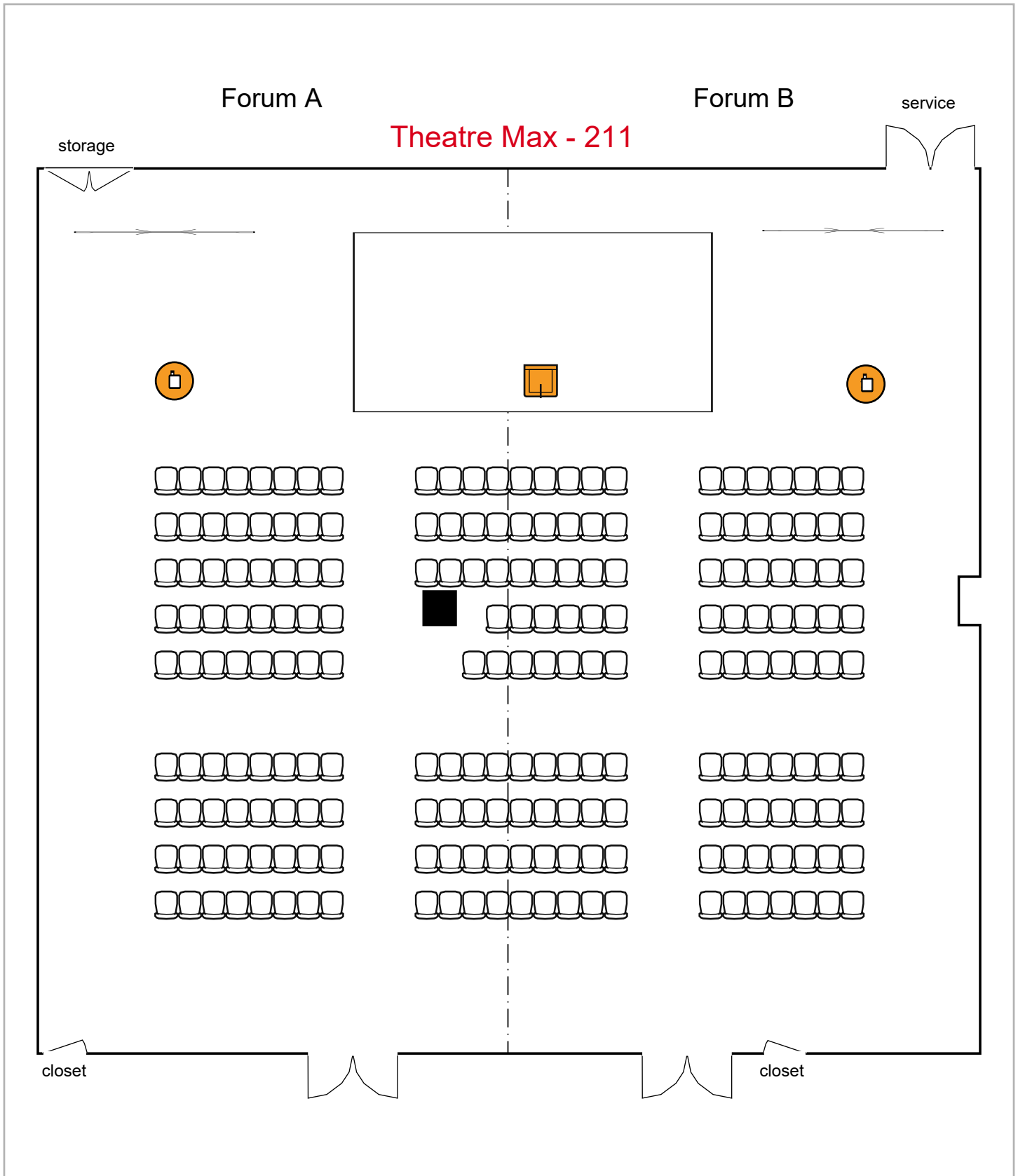

Room Plan Name: Forum A-B - Theatre

211 seats 2 tables
0 booths

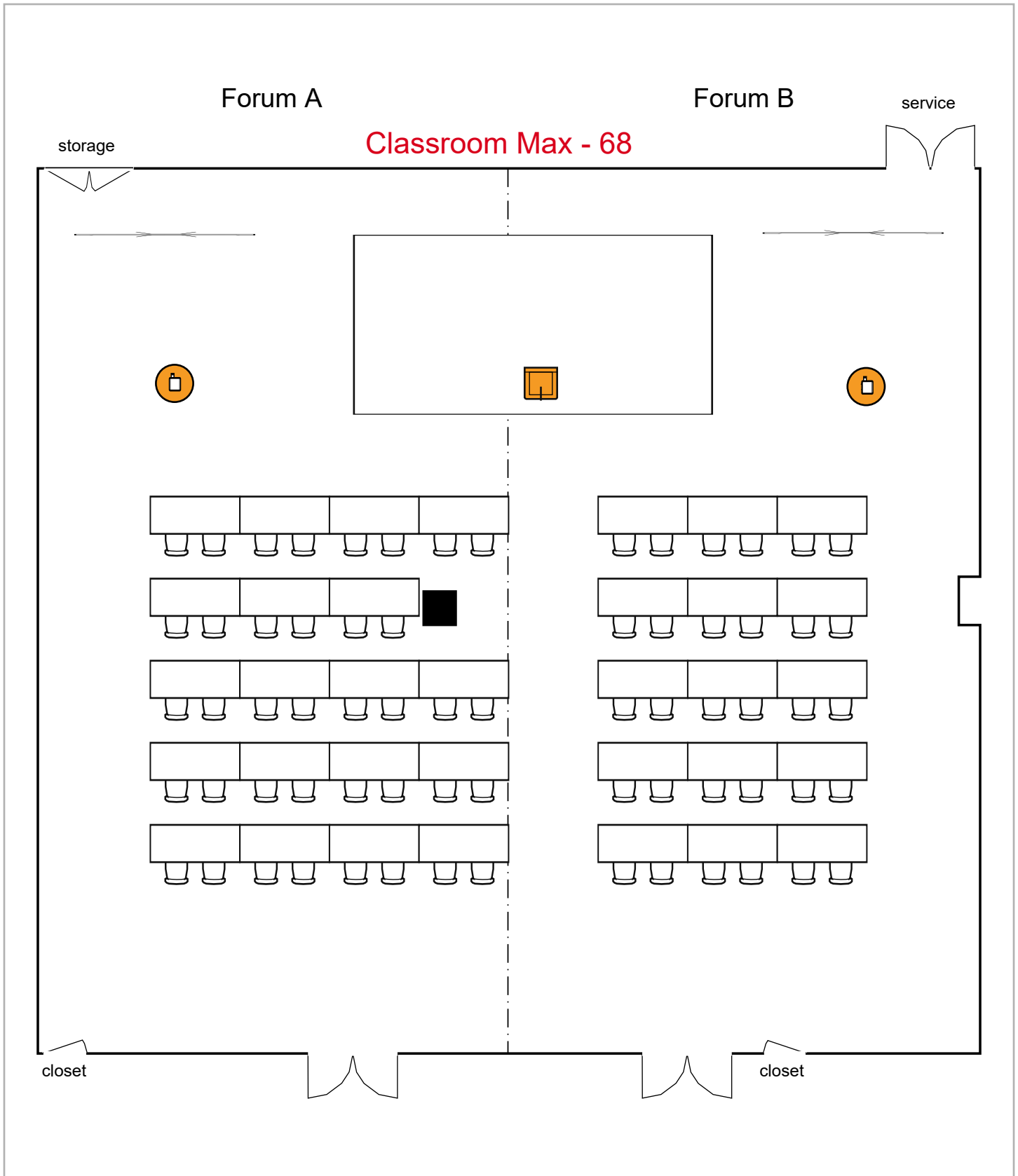

Room Plan Name: Forum A-B - Classroom

68 seats 36 tables
0 booths

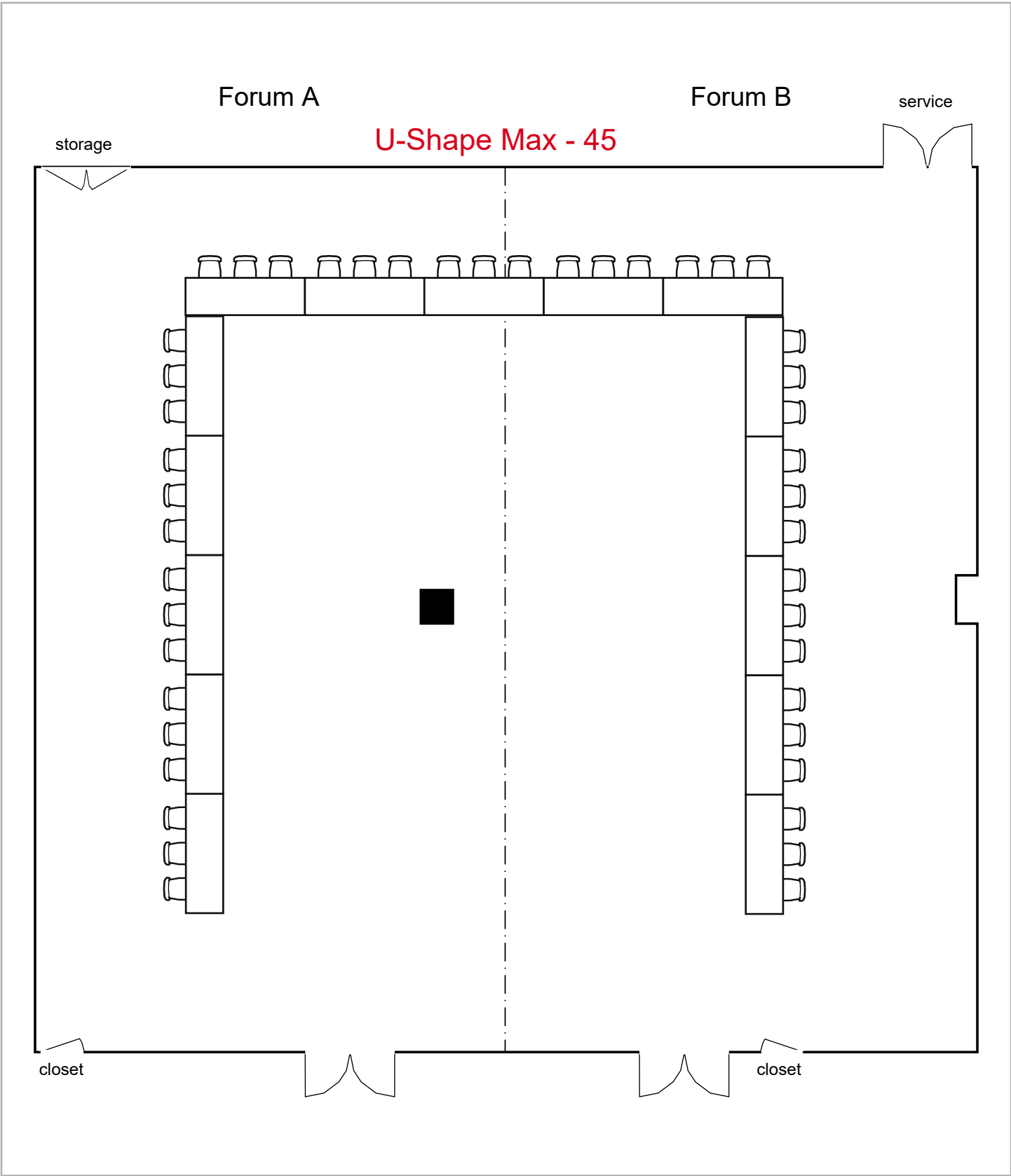

Room Plan Name: Forum A-B - U-Shape

45 seats 15 tables
0 booths

Forum A

Banquet Max - 160

Forum B

service

storage

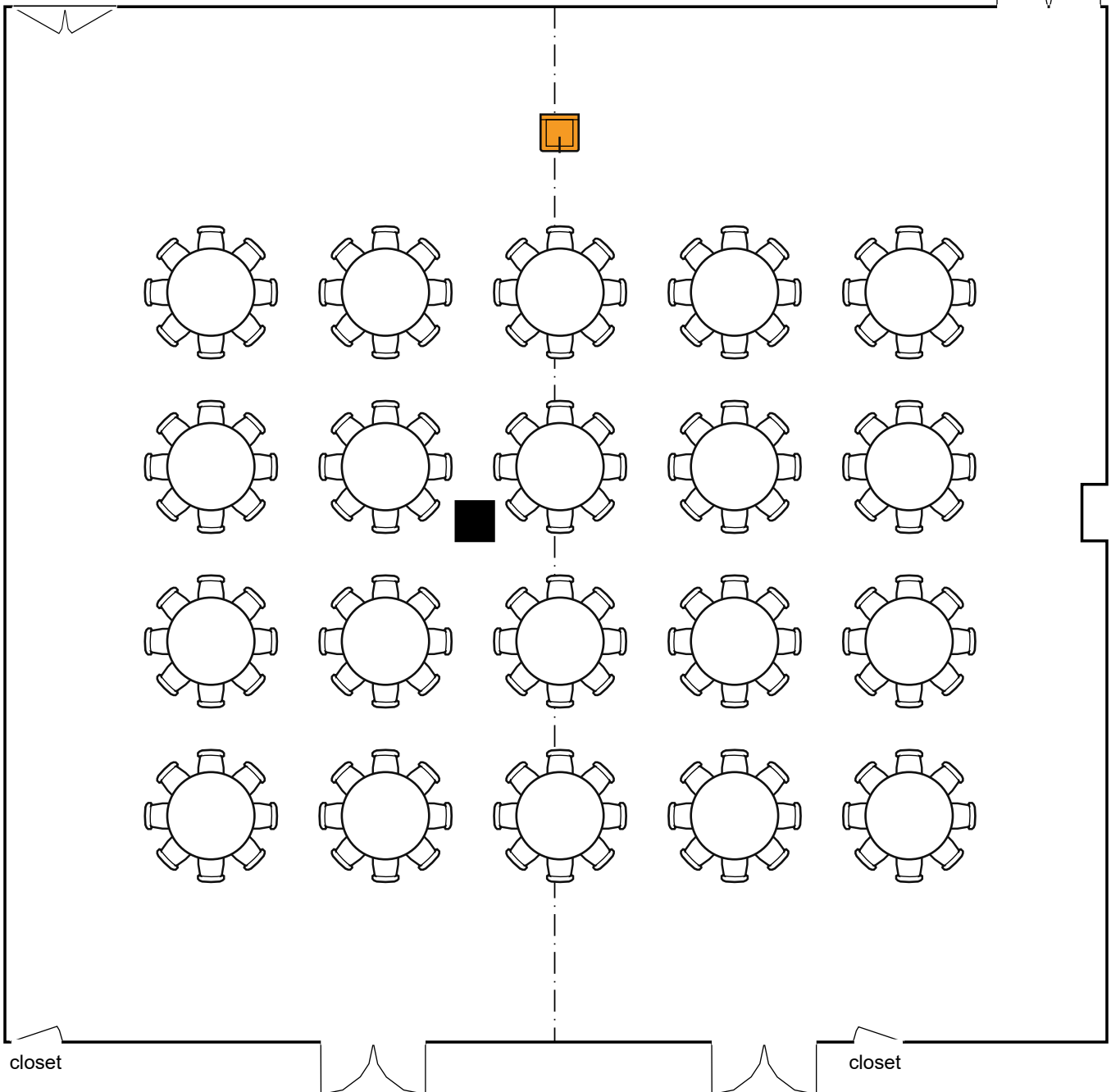

Room Plan Name: Forum A-B - Banquet

160 seats 20 tables
0 booths

Forum A

Forum B

service

storage

Theatre Max - 168

Theatre Max - 169

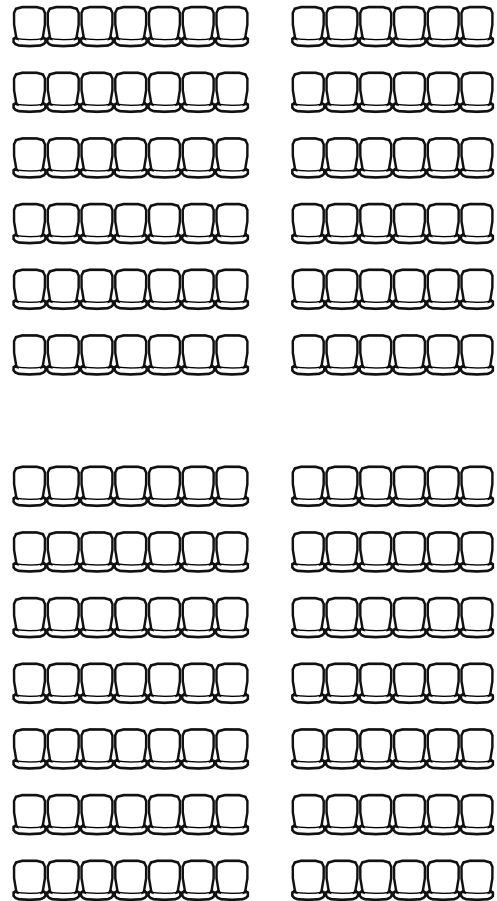
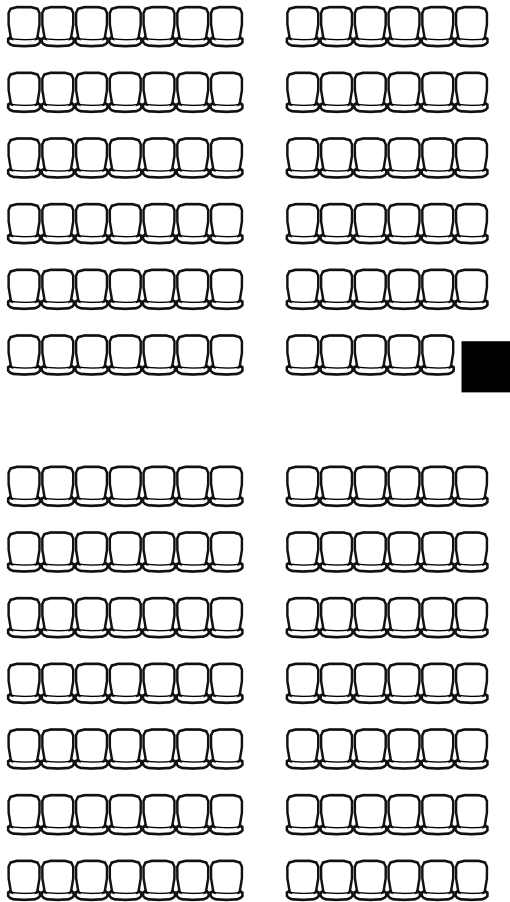

closet

closet



Room Plan Name: Forum AB - Theatre

337 seats 0 tables
0 booths

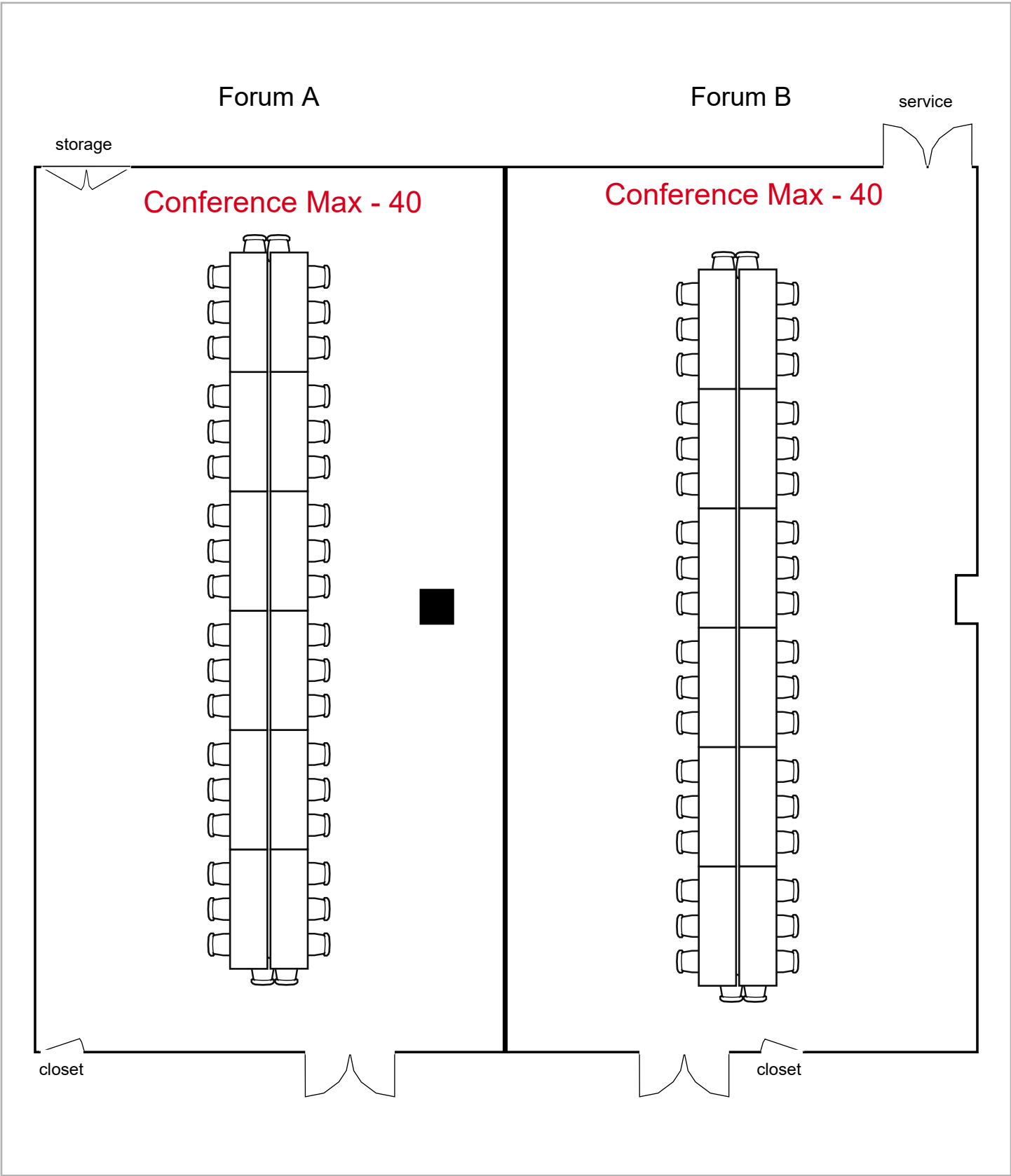

Room Plan Name: Forum AB - Conference

80 seats 24 tables
0 booths

Forum A

Forum B

service

storage

Classroom Max - 48

Classroom Max - 64

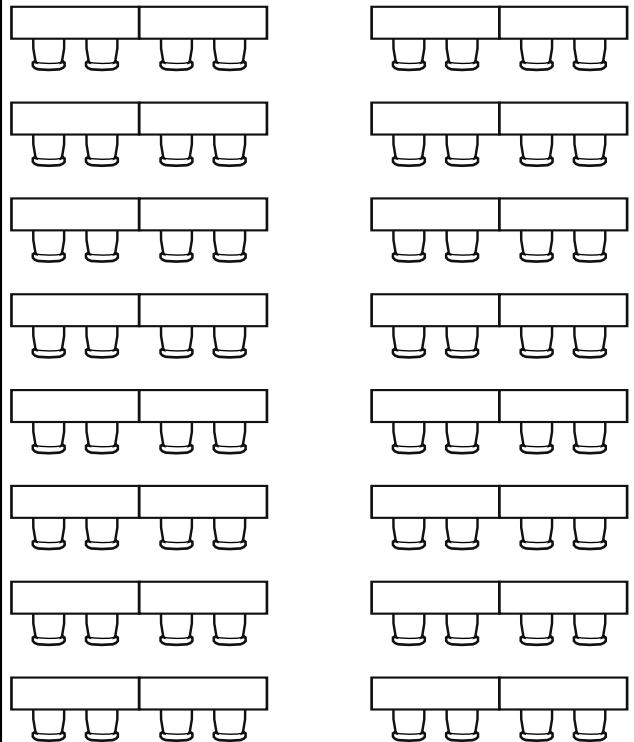
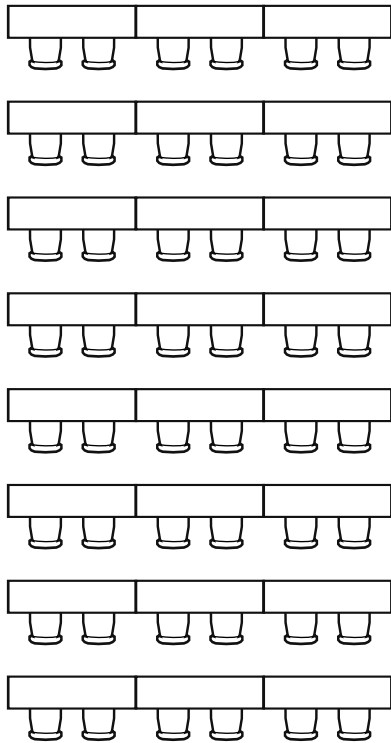

closet

closet



Room Plan Name: Forum AB - Classroom

112 seats 56 tables
0 booths

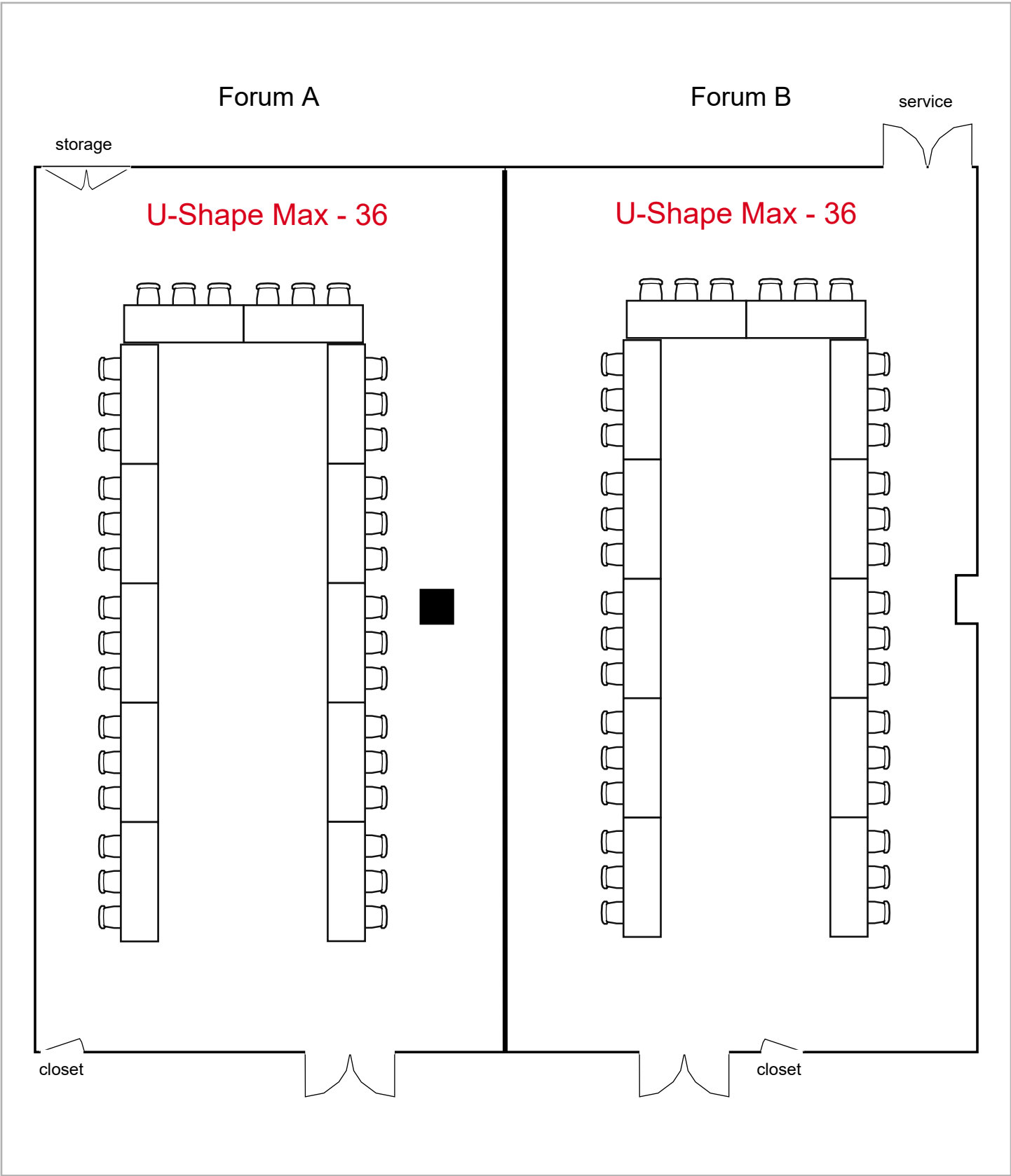

Room Plan Name: Forum AB - U-Shape

72 seats 24 tables
0 booths

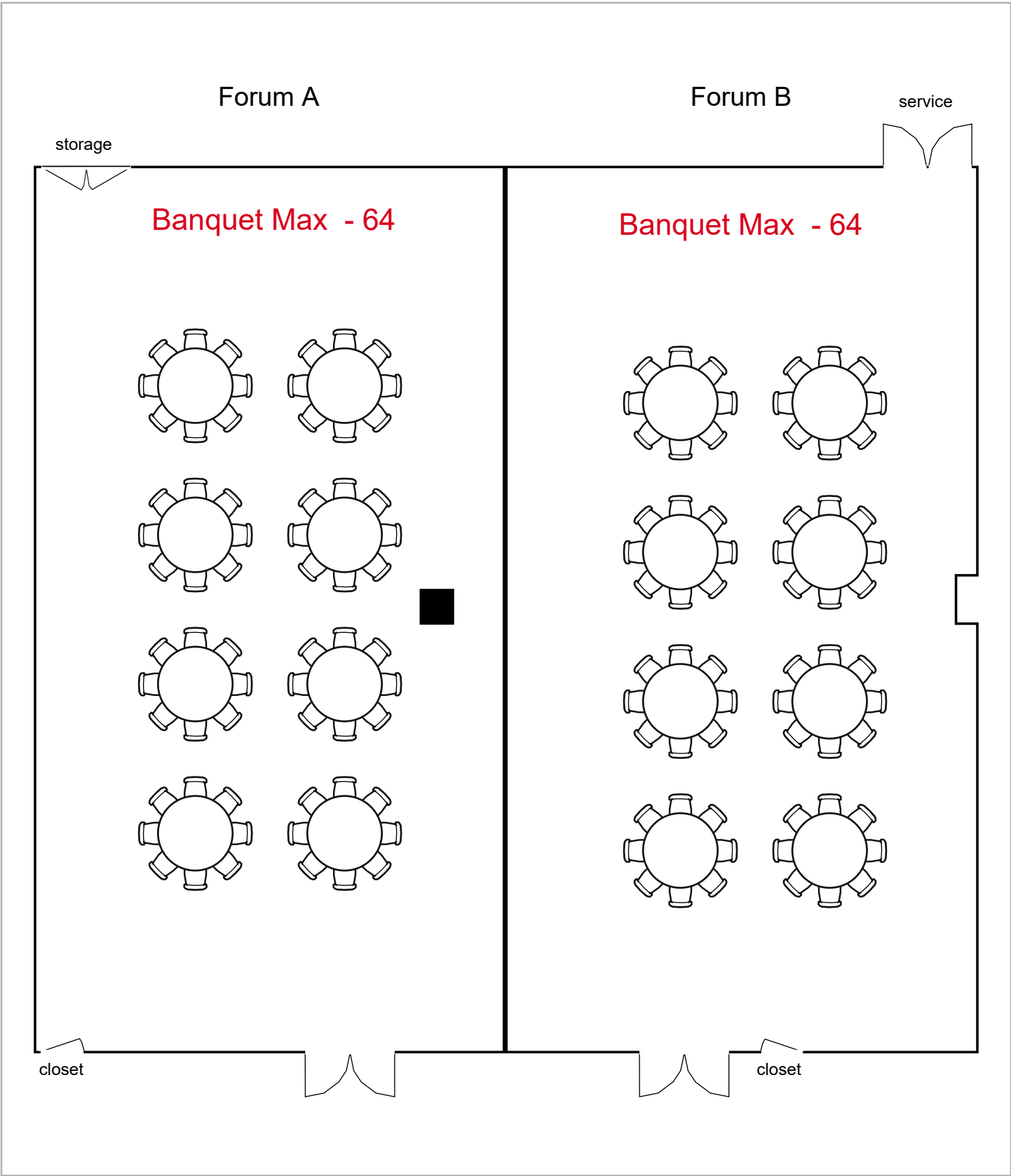

Room Plan Name: Forum AB - Banquet

128 seats 16 tables
0 booths

Forum C

screen

Theatre Max - 96

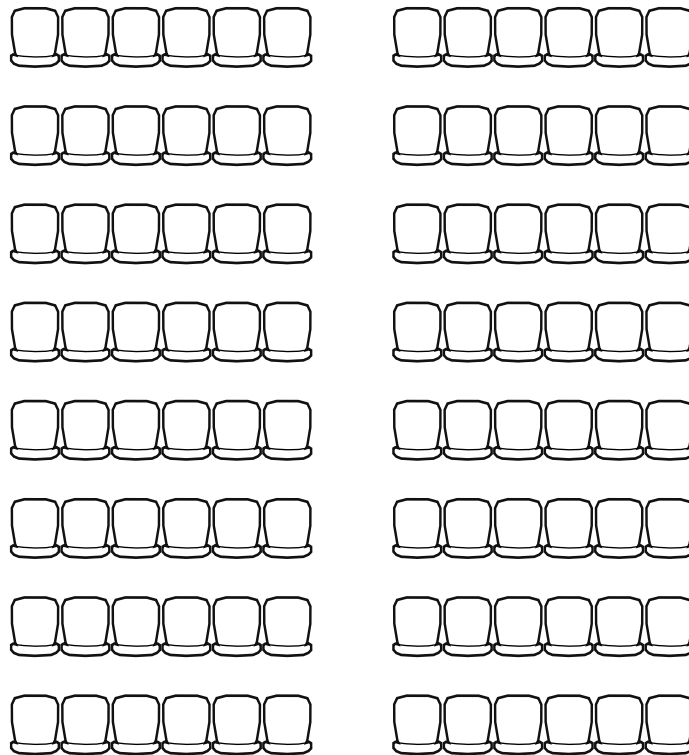

projection room

Birmingham Jefferson Convention Complex

96 seats 0 tables
0 booths

Room Plan Name: Forum C - Theatre

Forum C

screen

Conference Max - 28

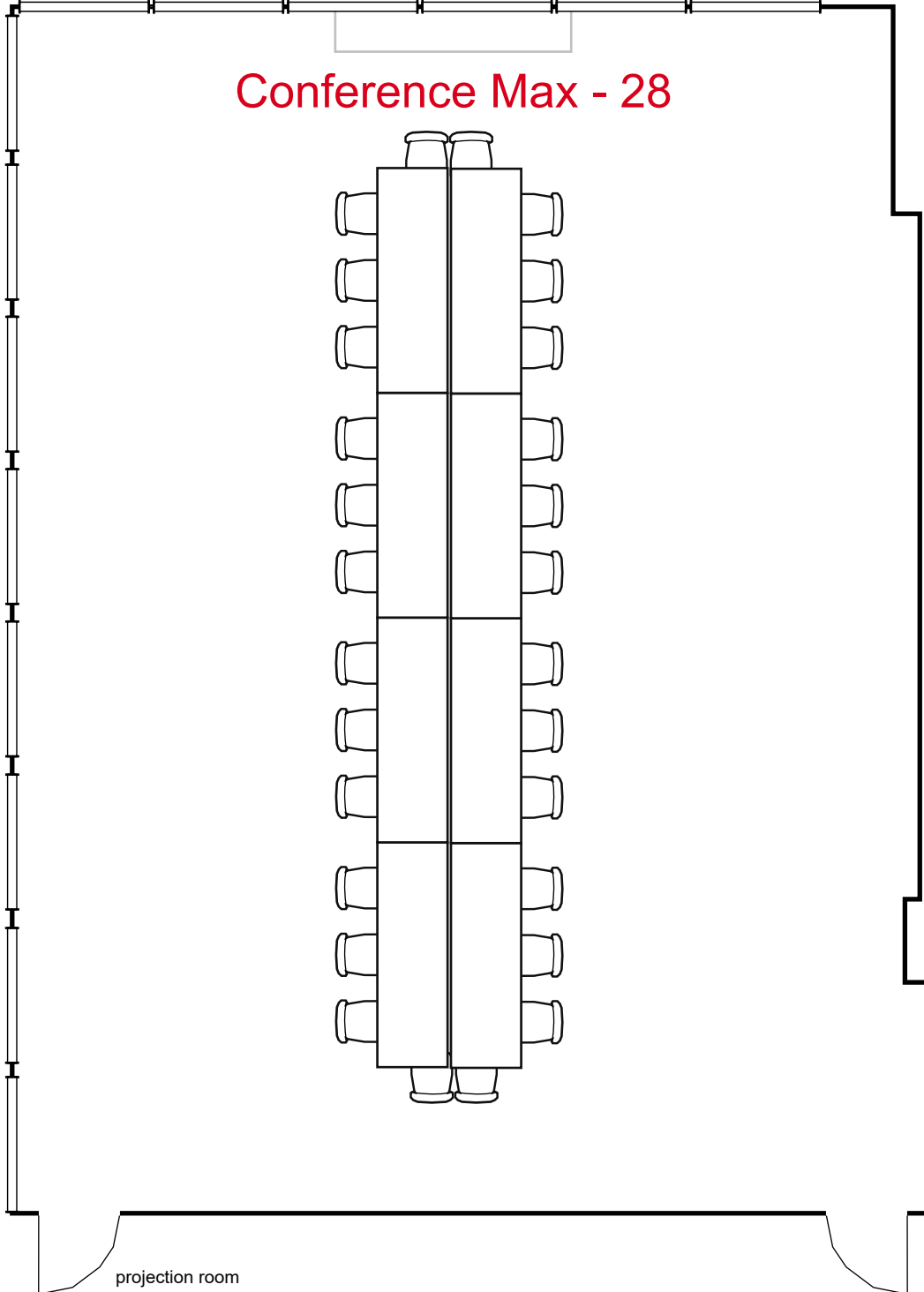

Room Plan Name: Forum C - Conference

28 seats 8 tables
0 booths

Forum C

screen

Classroom Max - 40

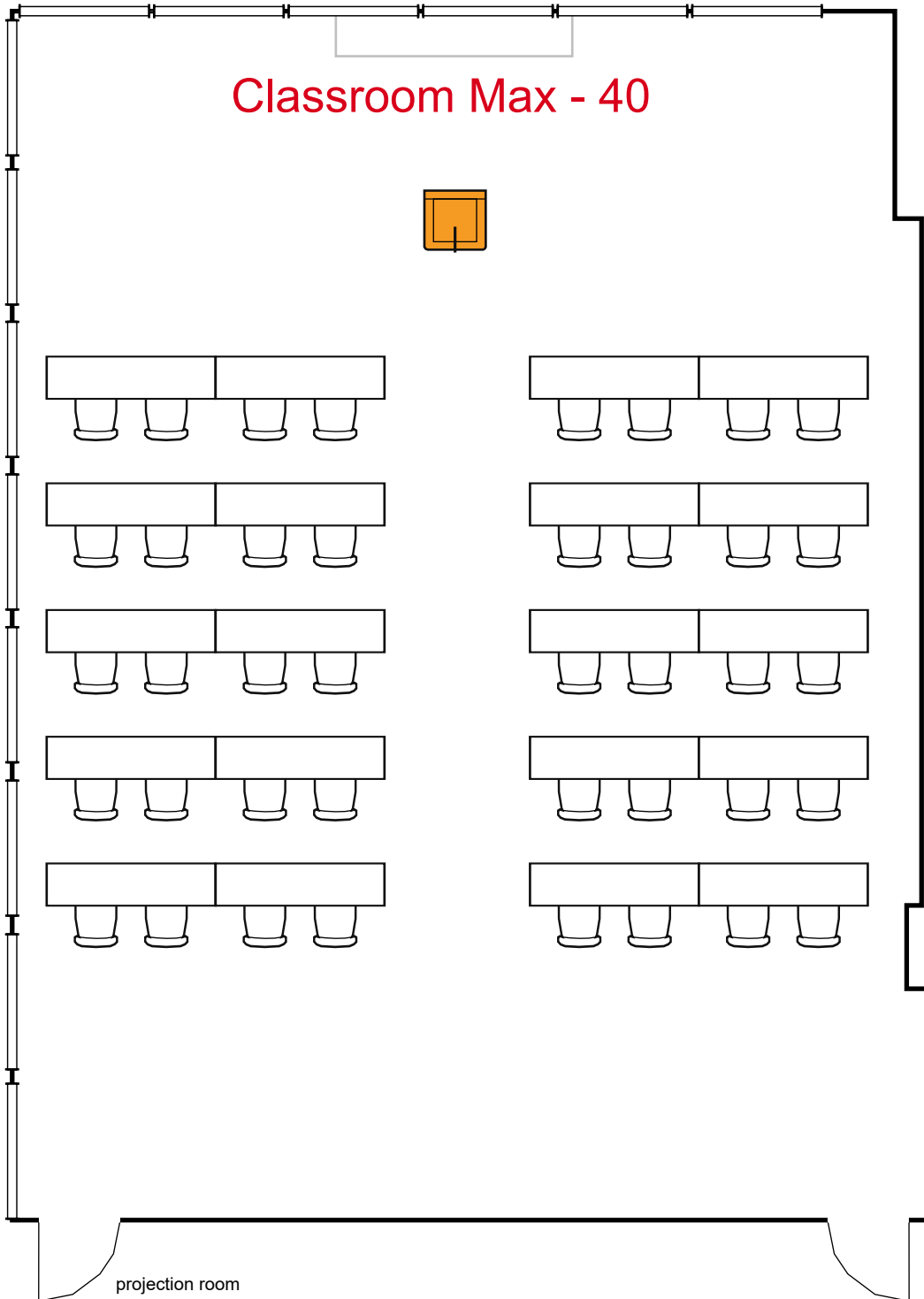

Room Plan Name: Forum C - Classroom

40 seats 20 tables
0 booths

Forum C

screen

U-Shape Max - 24

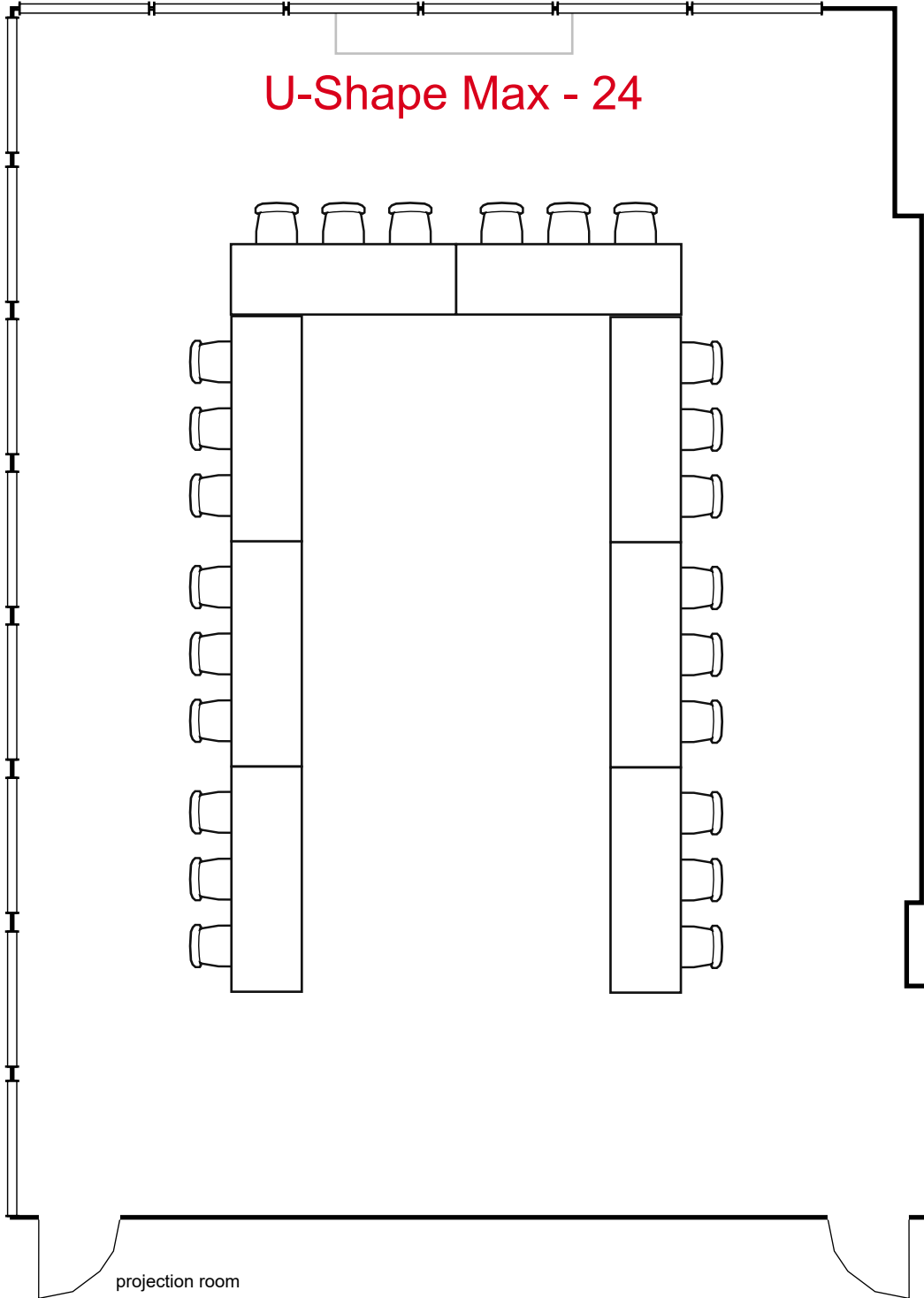

Room Plan Name: Forum C - U-Shape

24 seats 8 tables
0 booths

Forum C

screen

Banquet Max - 48

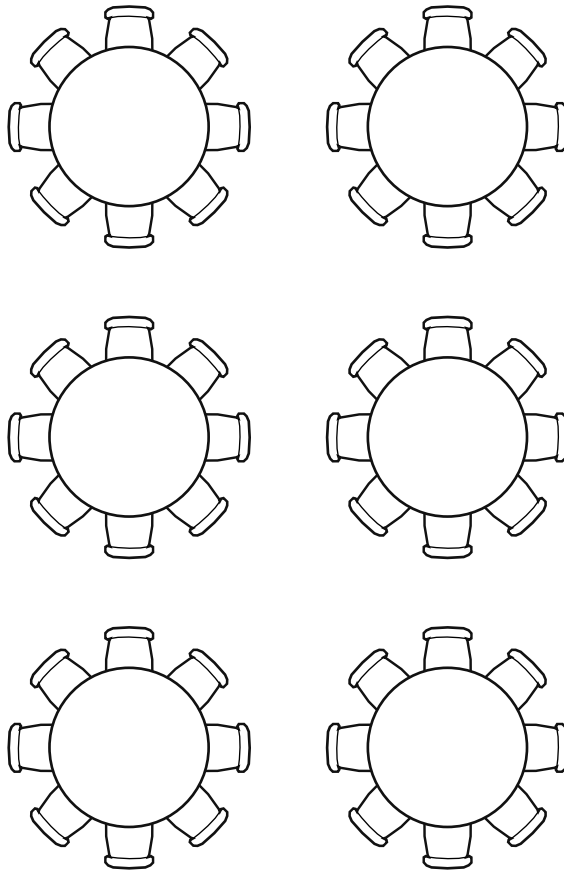

projection room



Room Plan Name: Forum C - Banquet

48 seats 6 tables
0 booths

Forum D

screen

Conference Max - 16

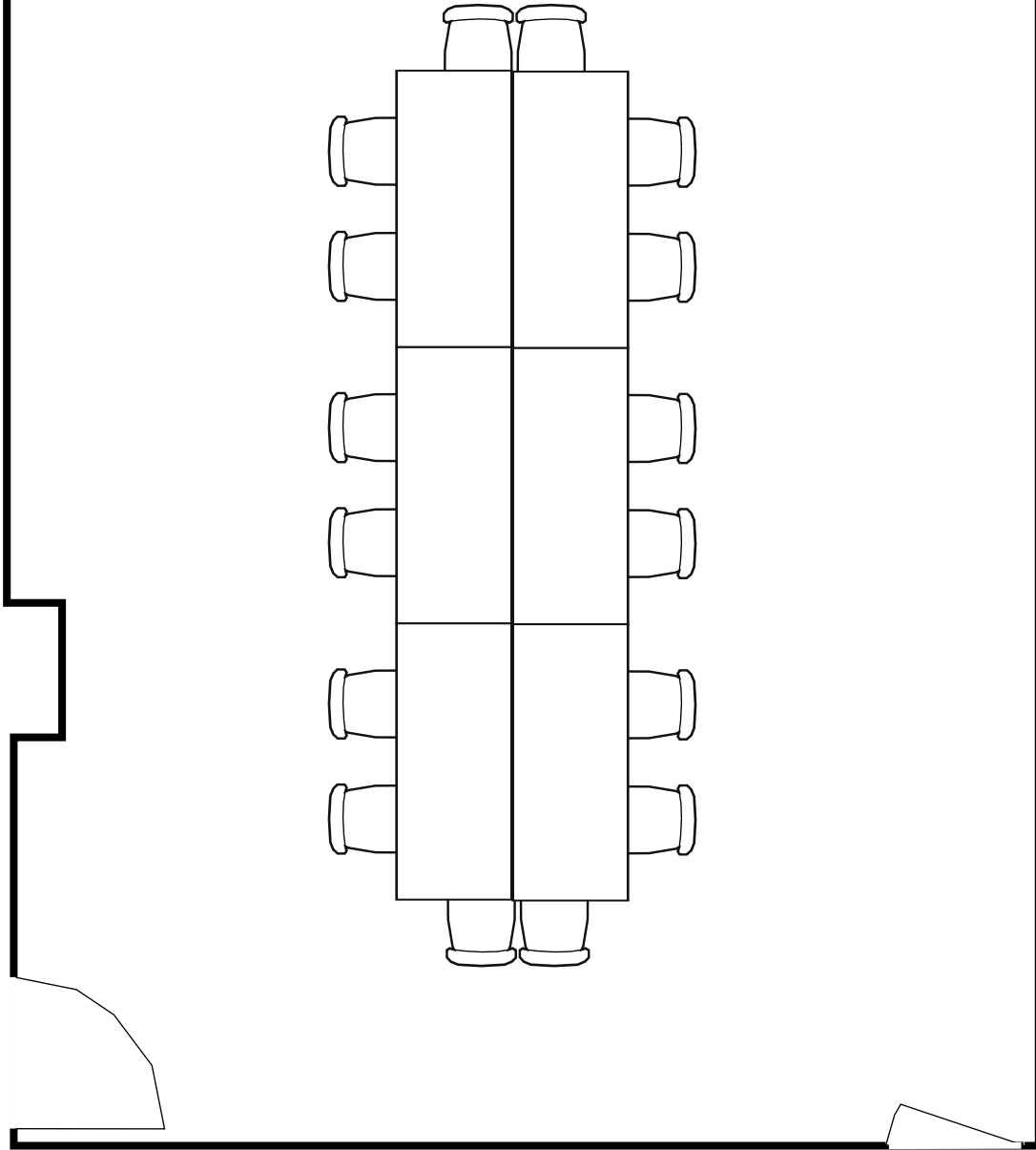

projection room



Room Plan Name: Forum D - Conference

16 seats 6 tables
0 booths

Forum D

screen

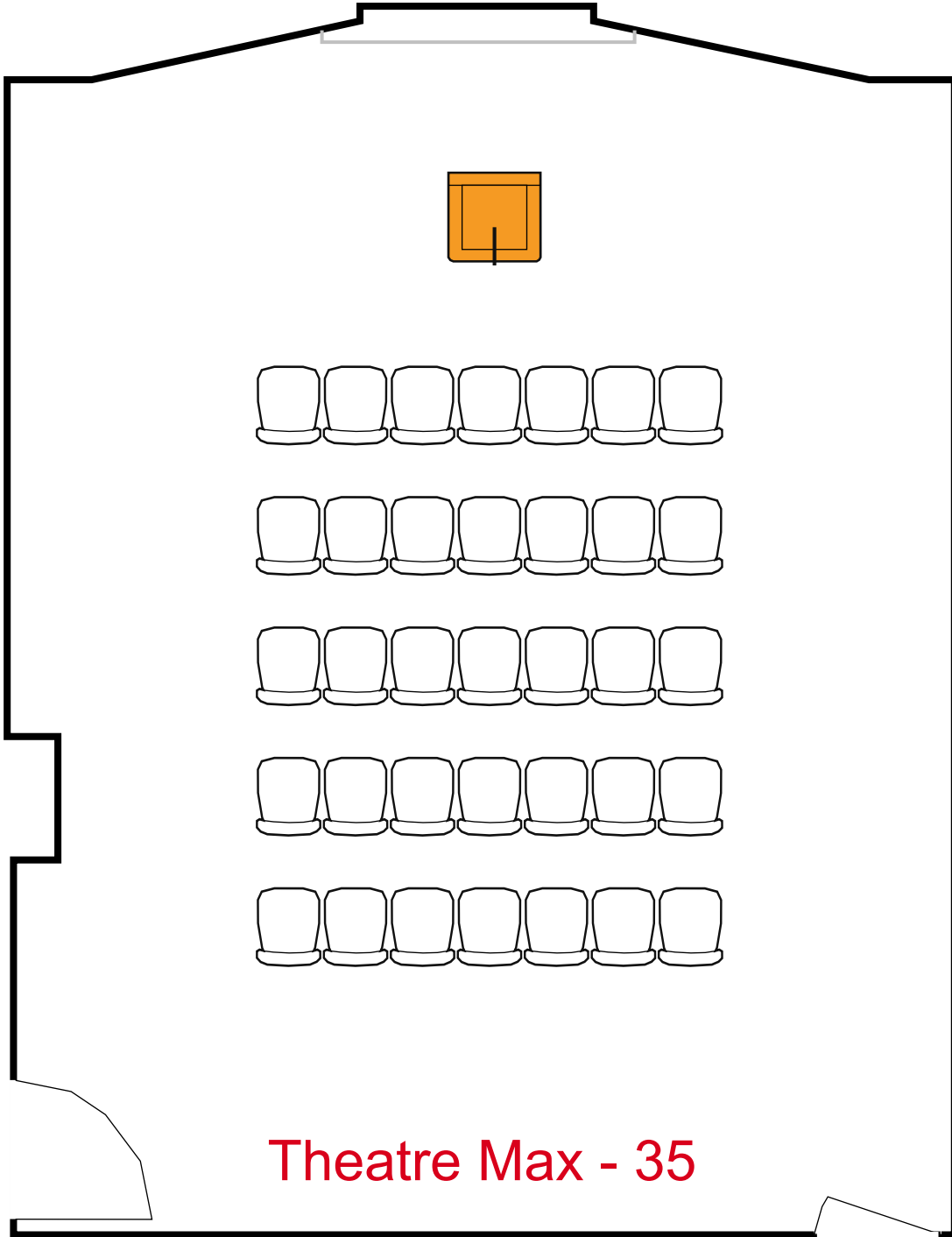

projection room



Room Plan Name: Forum D - Theatre

35 seats 0 tables
0 booths

Forum D

screen

Classroom Max - 16

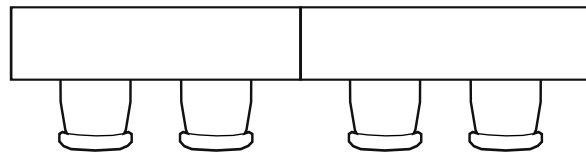
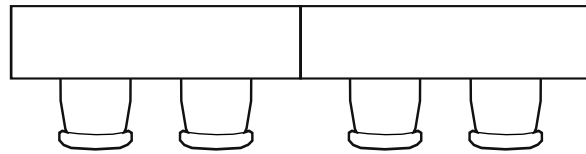
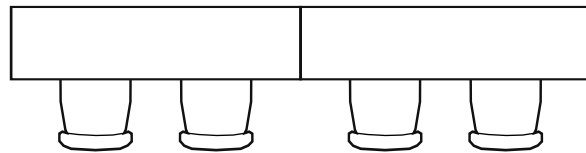
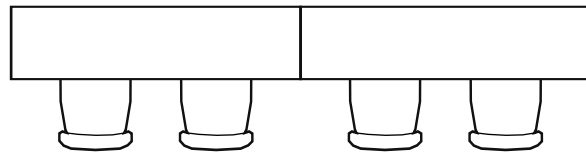
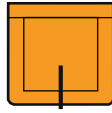

projection room



Room Plan Name: Forum D - Classroom

16 seats 8 tables
0 booths

Forum D

screen

U-Shape Max - 15

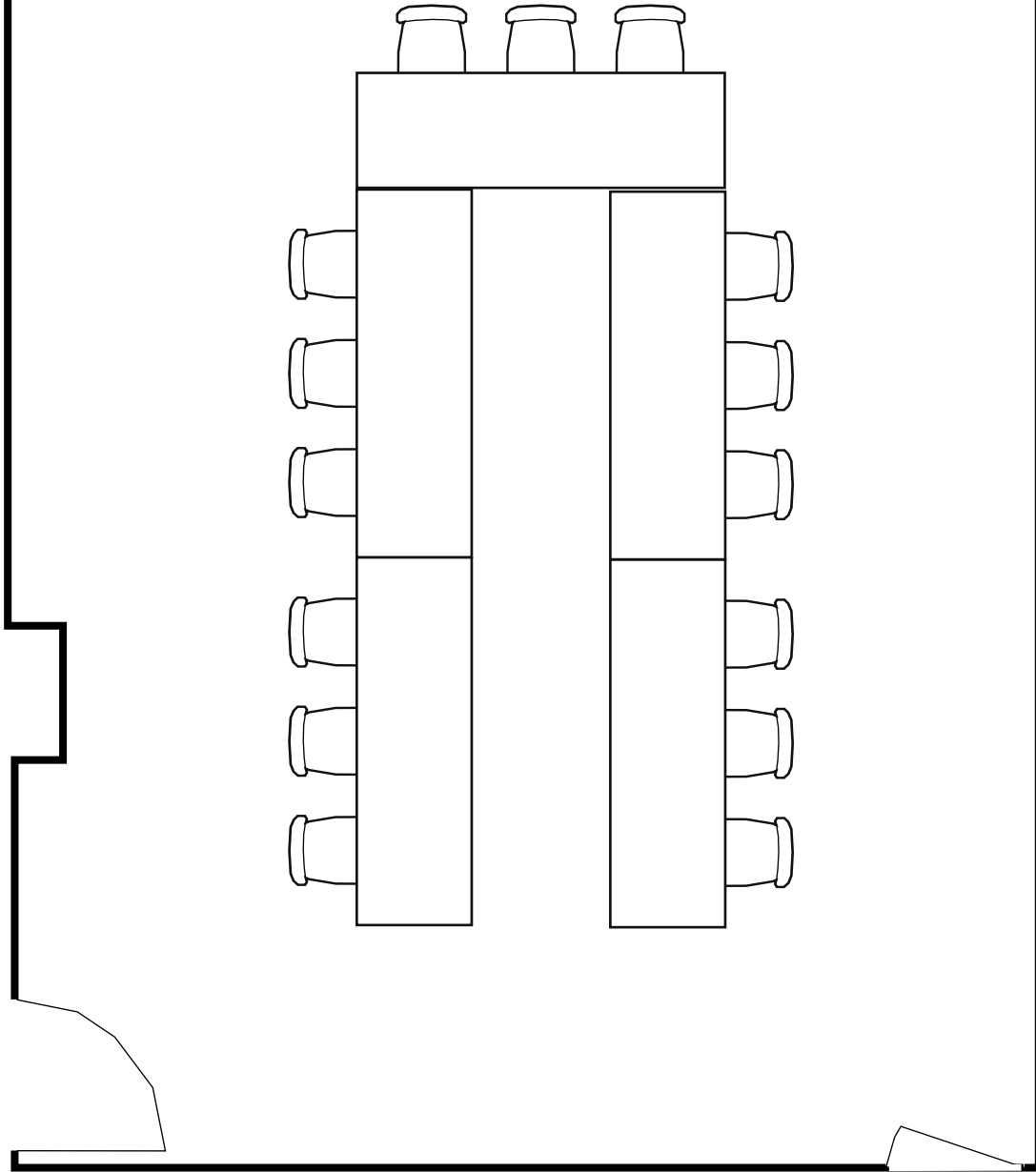

projection room



Room Plan Name: Forum D - U-Shape

15 seats 5 tables
0 booths

Forum D

screen

Banquet Max - 16

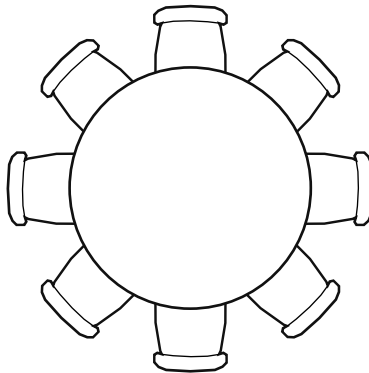
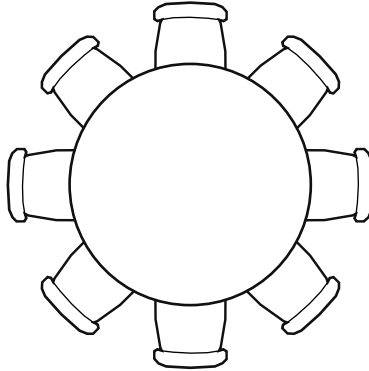

projection room



Room Plan Name: Forum D - Banquet

16 seats 2 tables
0 booths

Forum F

Conference Max -16

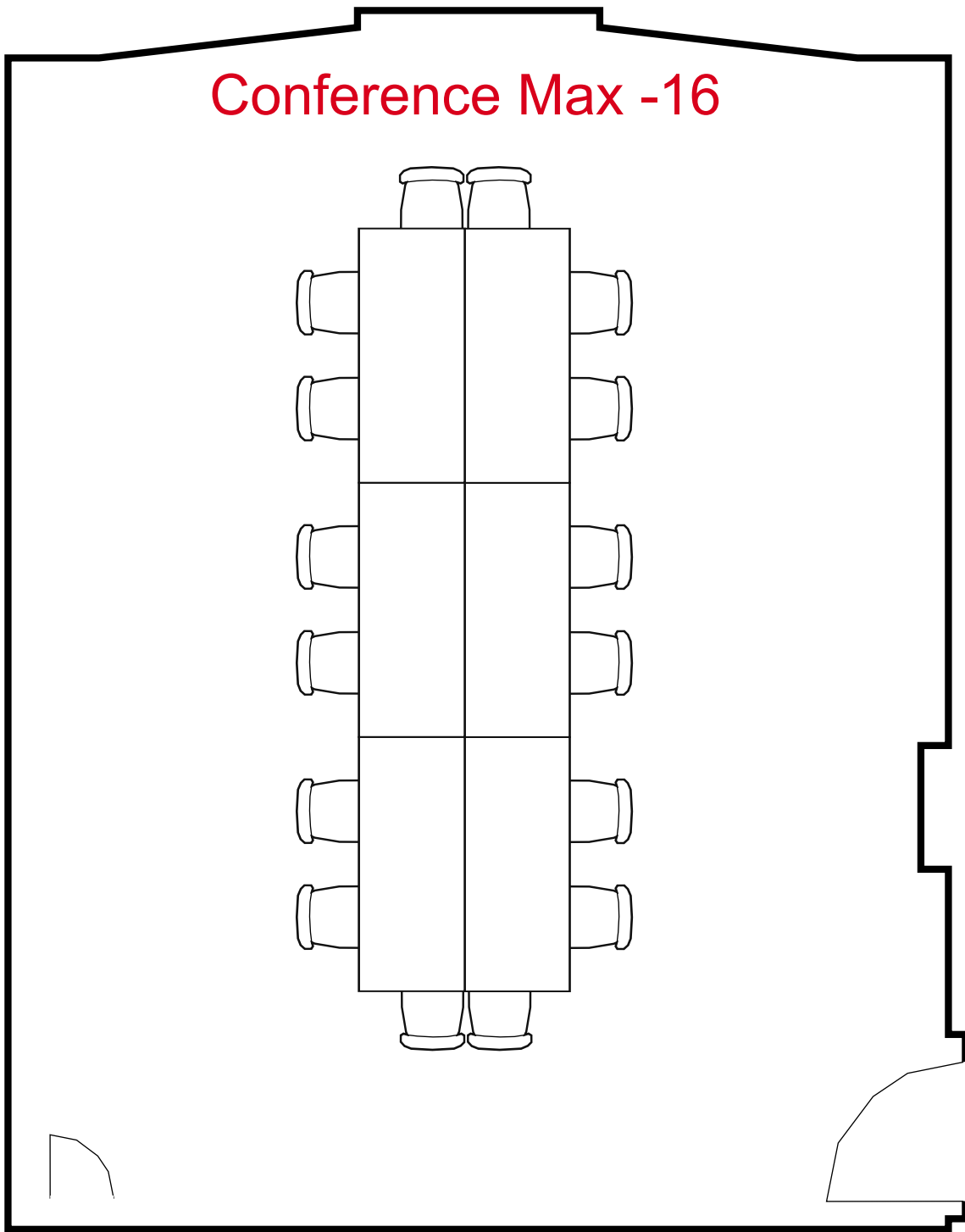

projection room



Room Plan Name: Forum F - Conference

16 seats 6 tables
0 booths

Forum F

Theatre Max - 40

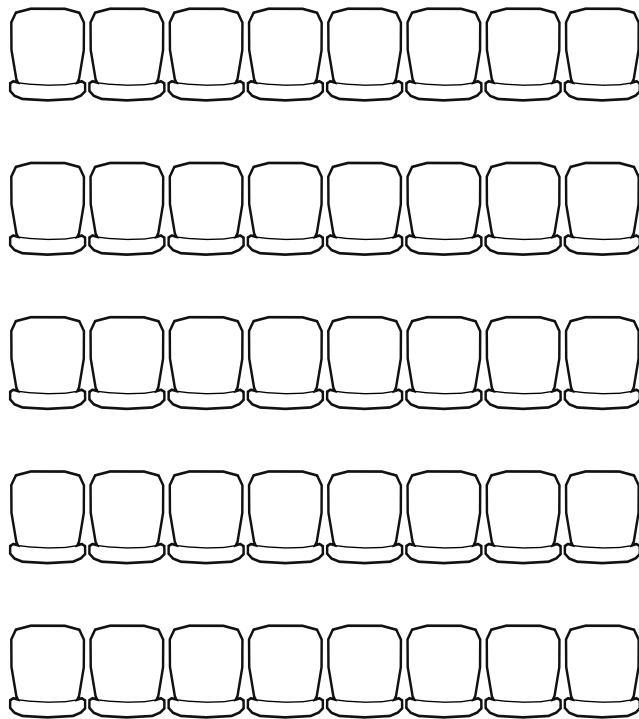
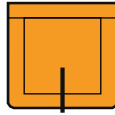

projection room



Room Plan Name: Forum F - Theatre

40 seats 0 tables
0 booths

Forum F

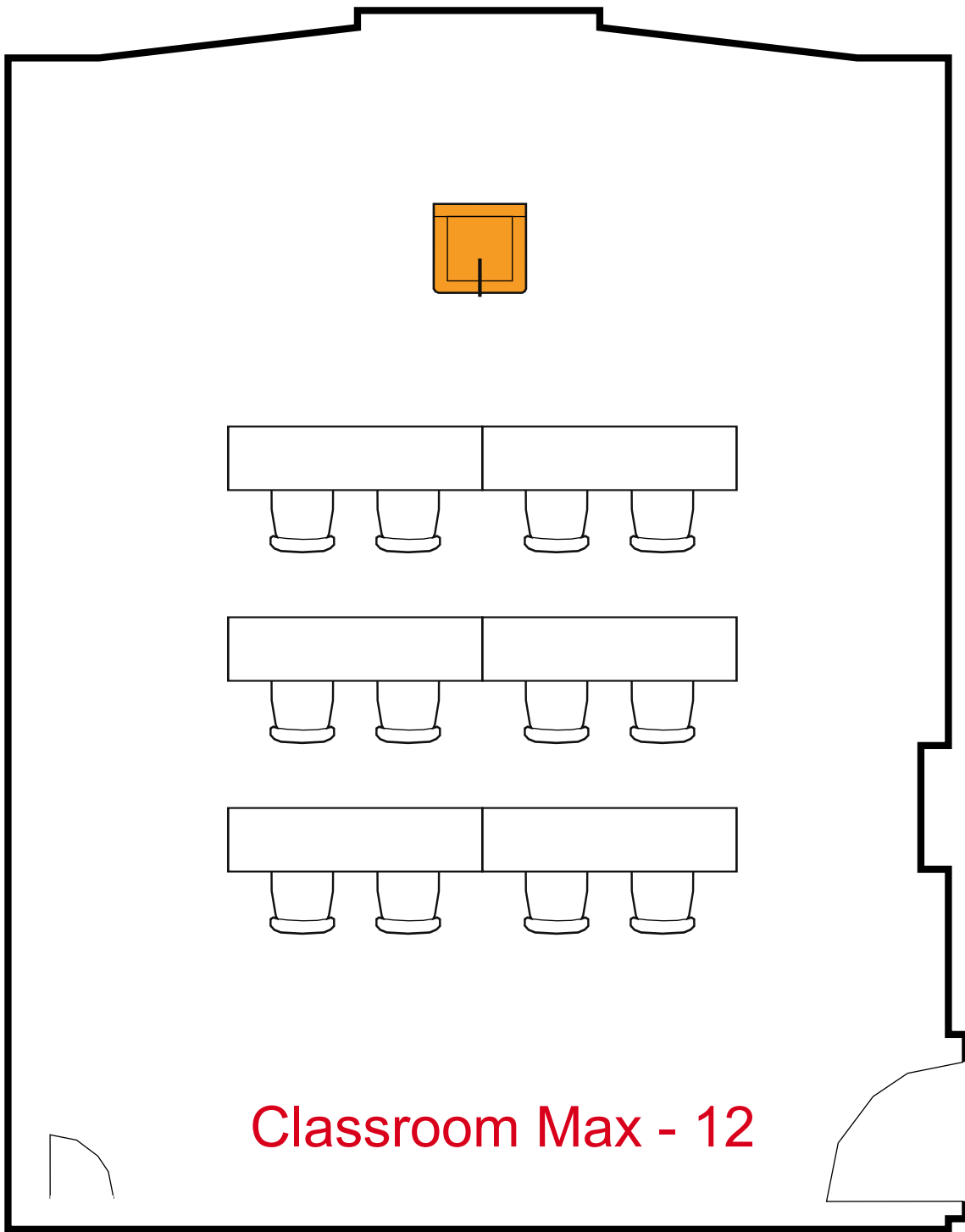

Classroom Max - 12

projection room



Room Plan Name: Forum F - Classroom

12 seats 6 tables
0 booths

Forum F

U-Shape Max - 15

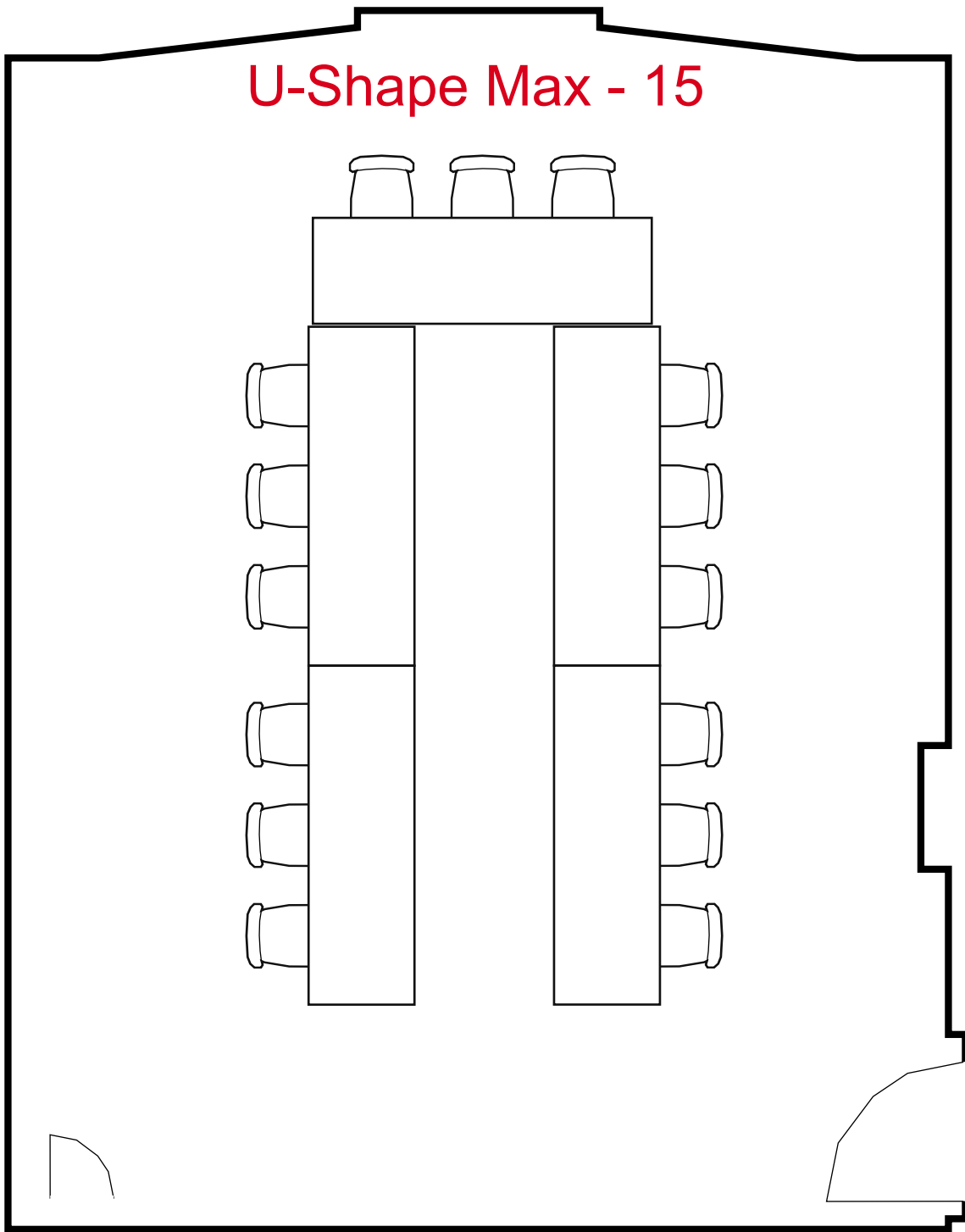

projection room



Room Plan Name: Forum F - U-Shape

15 seats 5 tables
0 booths

Forum F

Banquet Max - 16

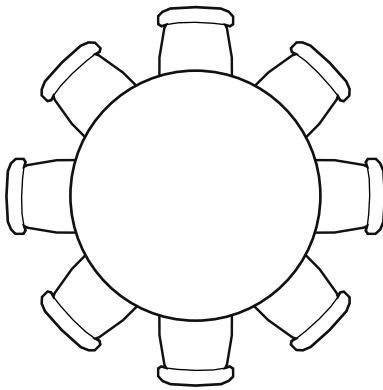
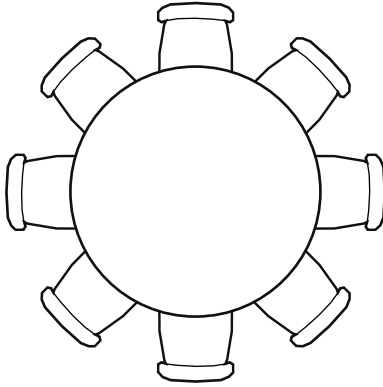

projection room



Room Plan Name: Forum F - Banquet

16 seats 2 tables
0 booths

Forum

3rd

Floor

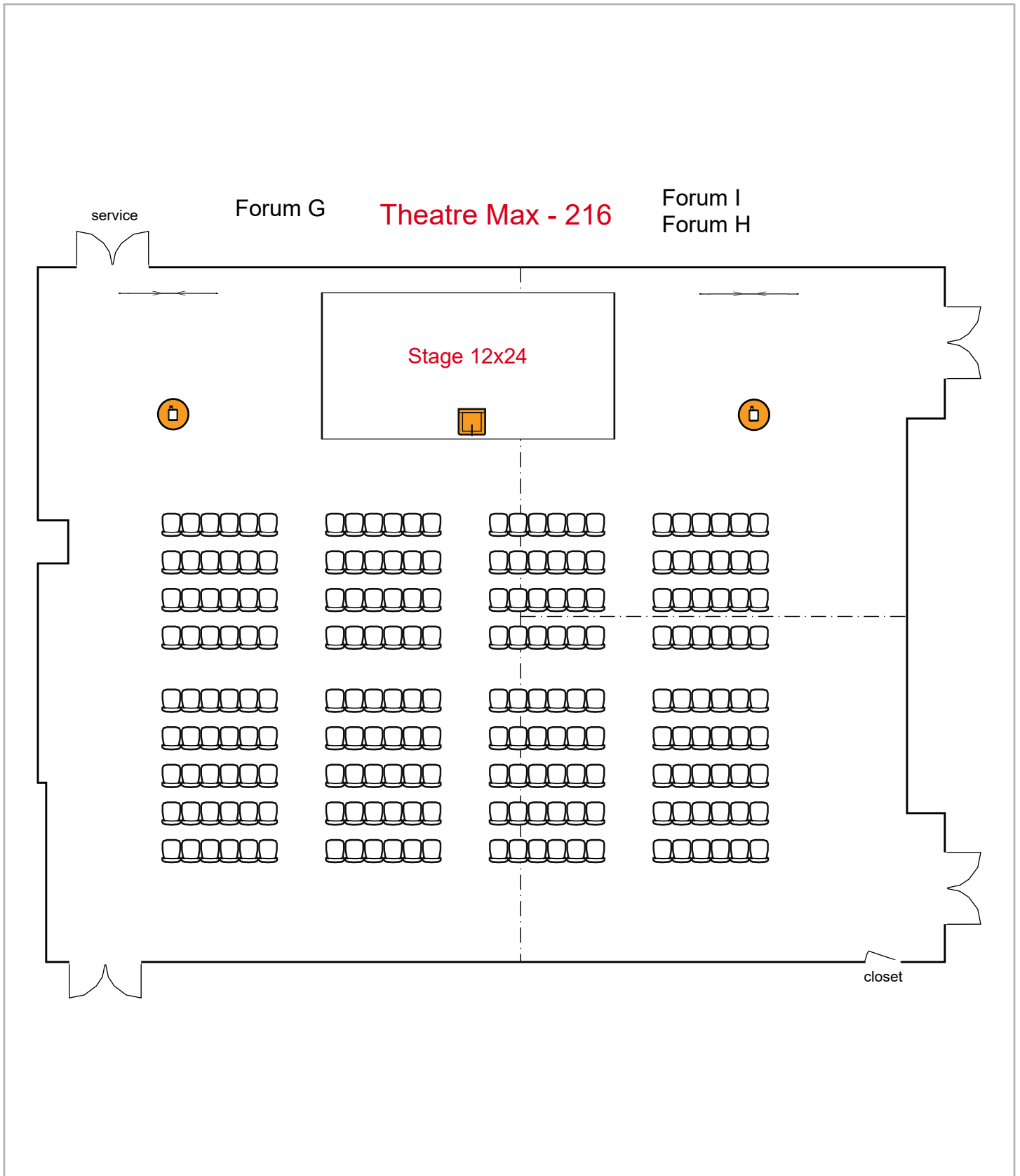

Room Plan Name: FORUM G-I - Theatre

216 seats 2 tables
0 booths

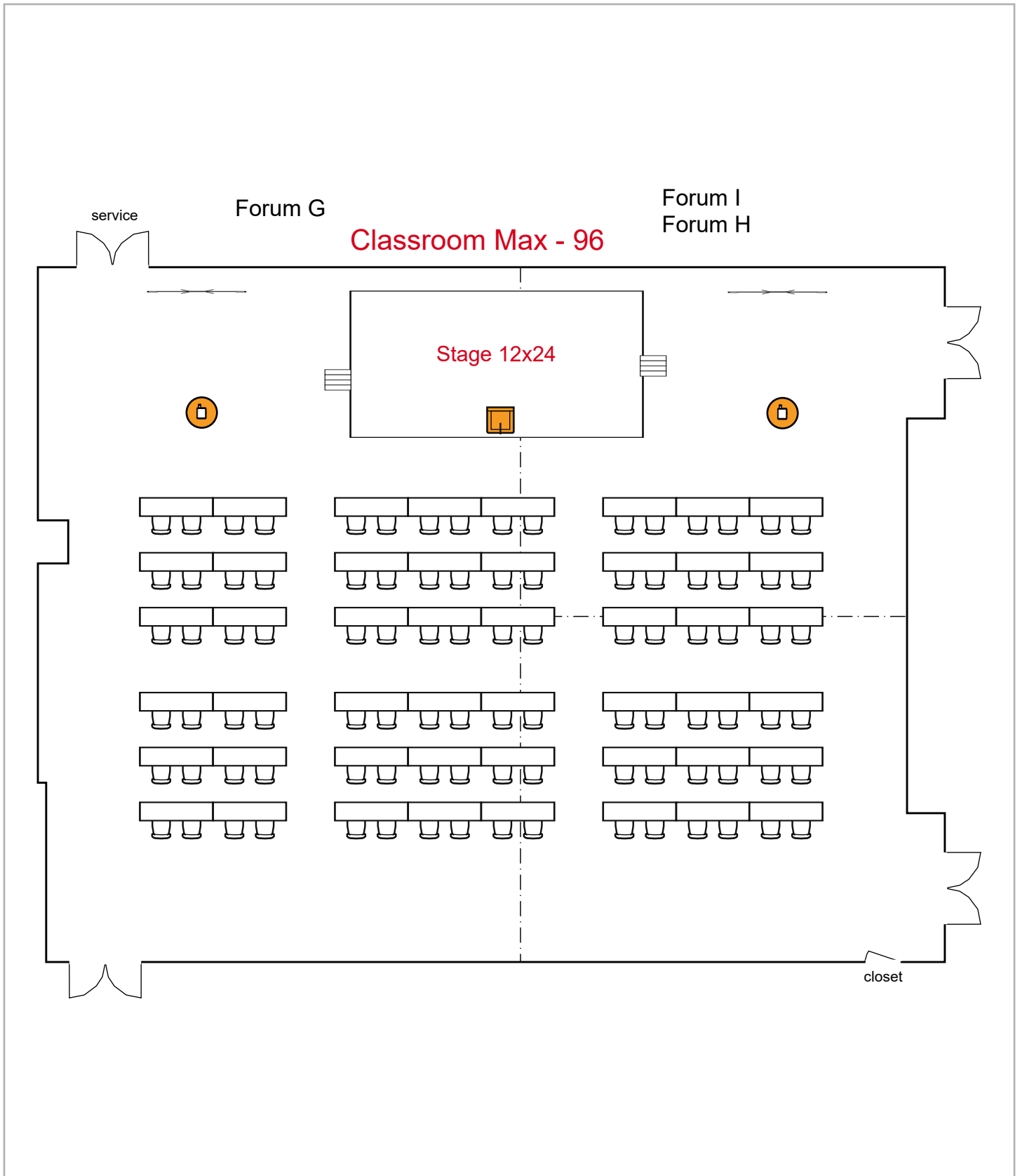

Room Plan Name: Forum G-I - Classroom

96 seats 50 tables
0 booths

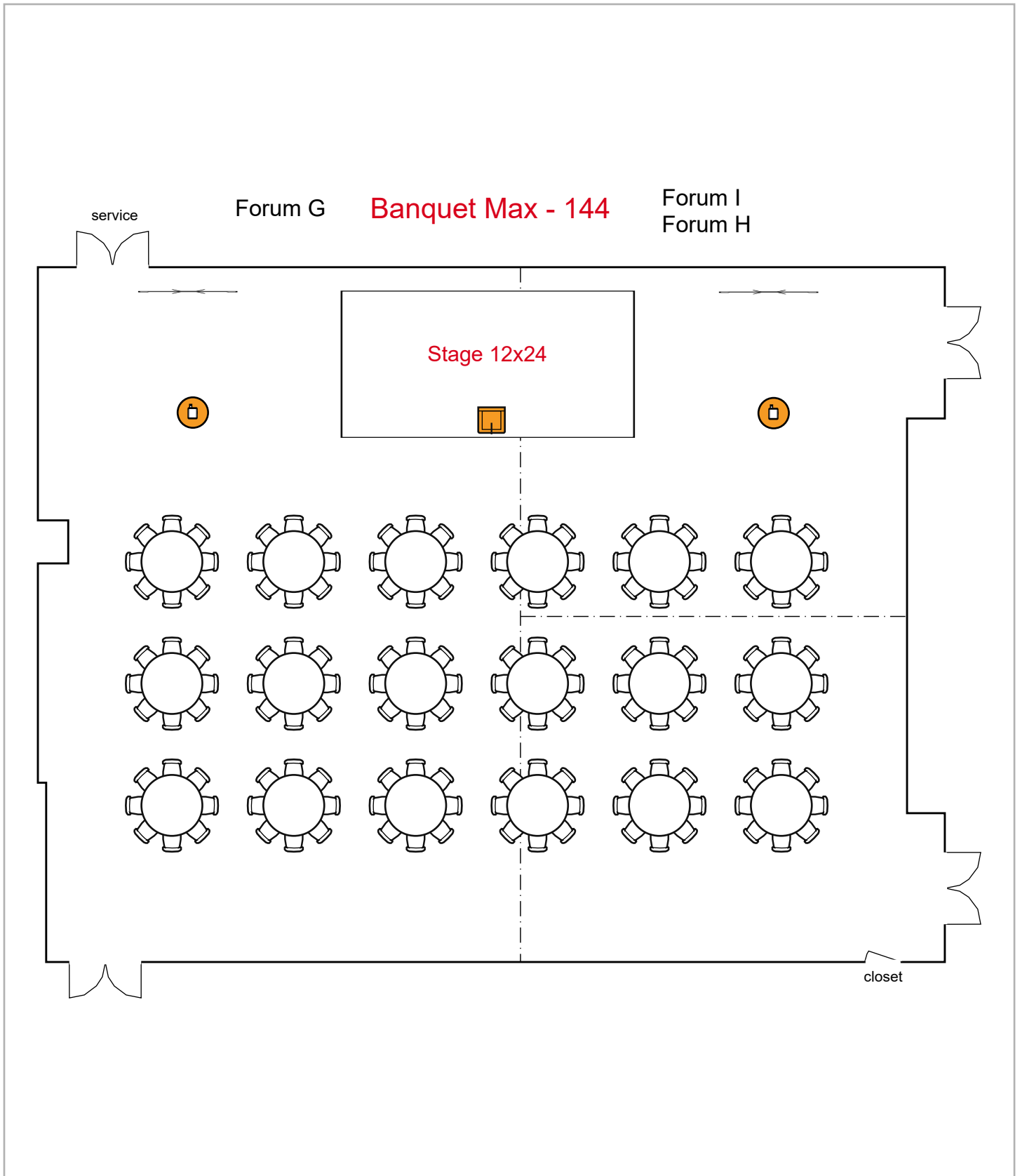

Room Plan Name: Forum G-I - Banquet

144 seats 20 tables
0 booths

Forum I
Forum H

Conference Max - 34

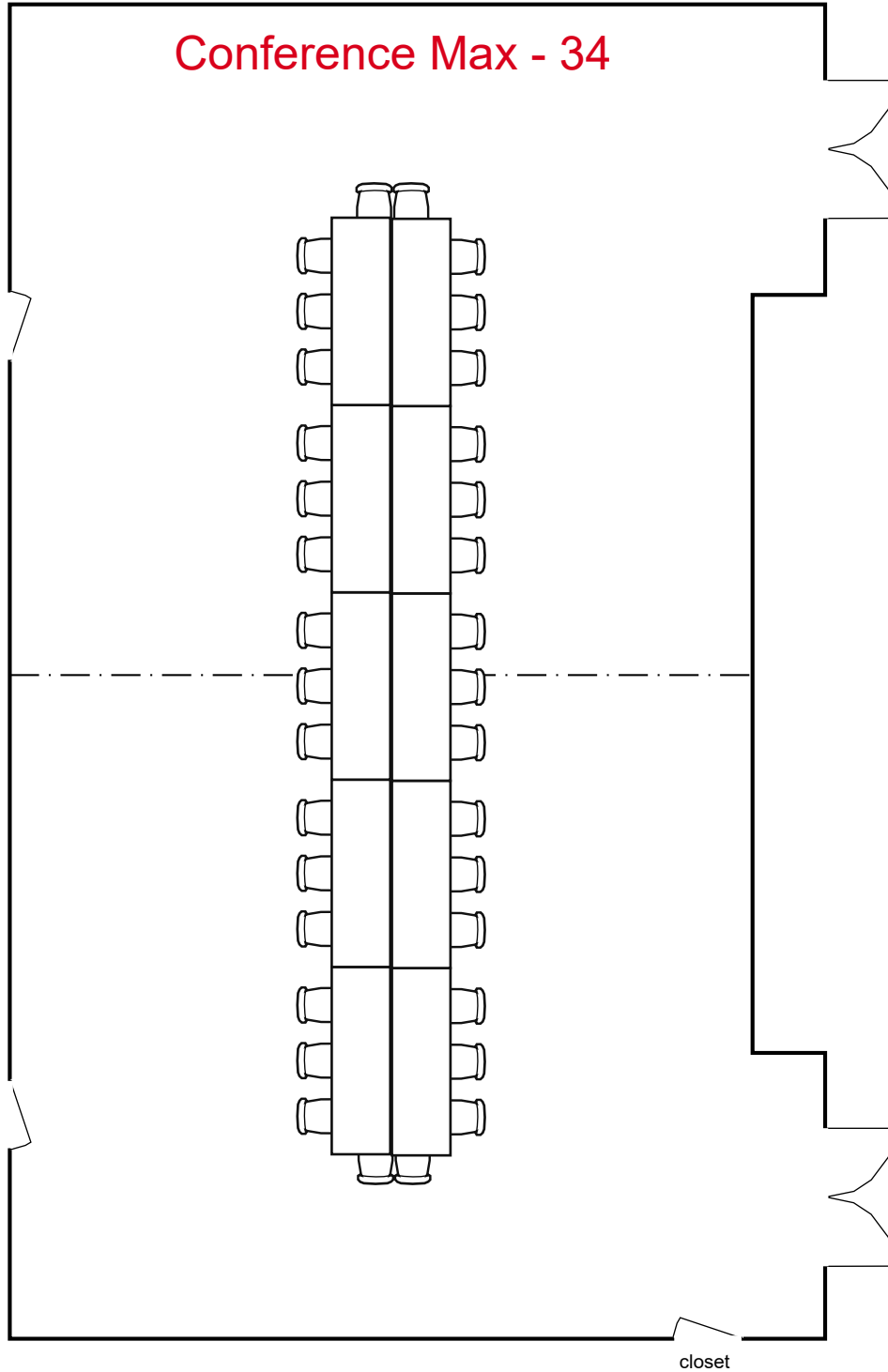

Room Plan Name: Forum H-I - Conference

34 seats 10 tables
0 booths

Forum I
Forum H

Theatre Max - 132

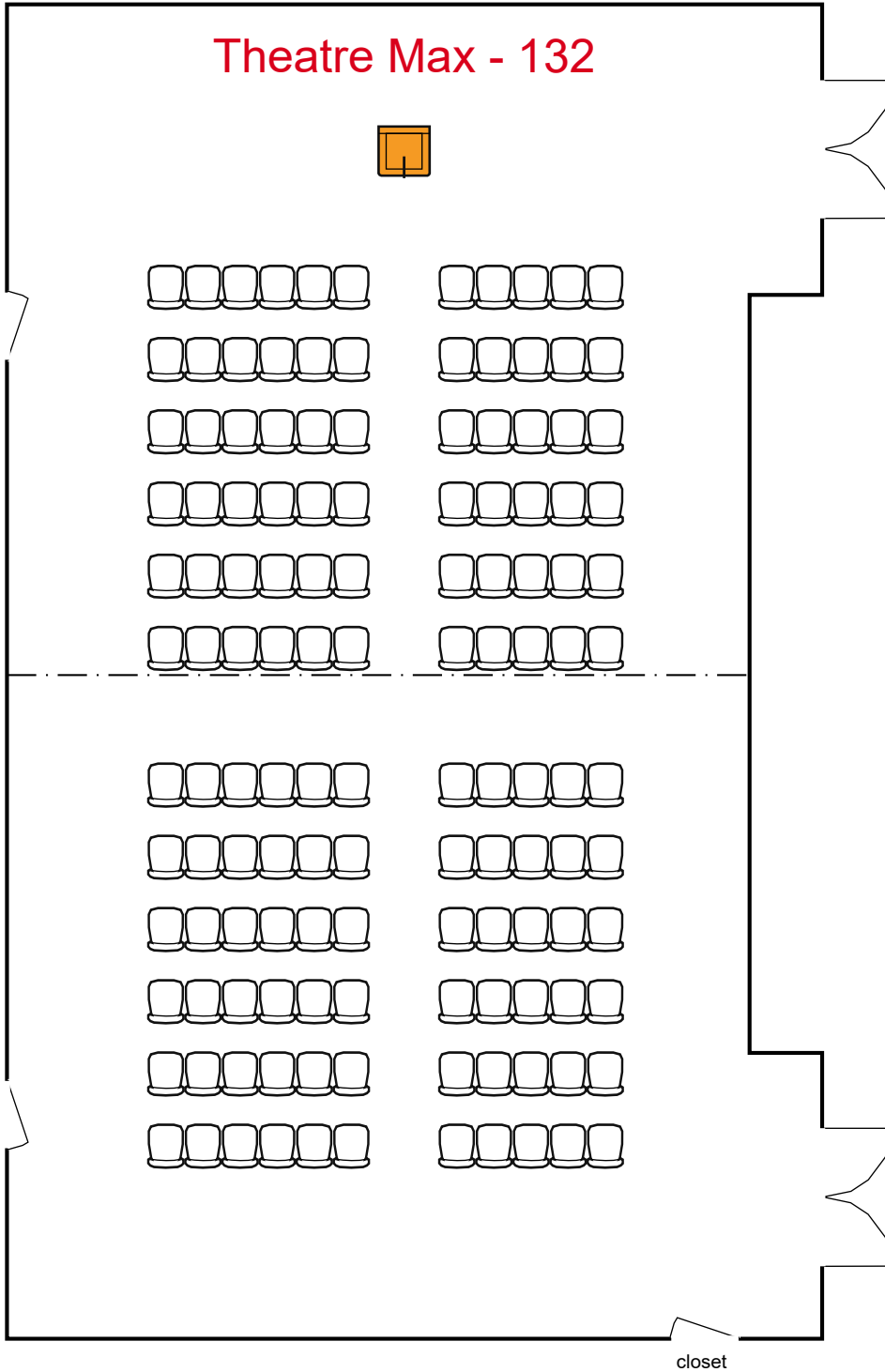

Room Plan Name: Forum H-I - Theatre

132 seats 0 tables
0 booths

Forum I
Forum H

Classroom Max - 72

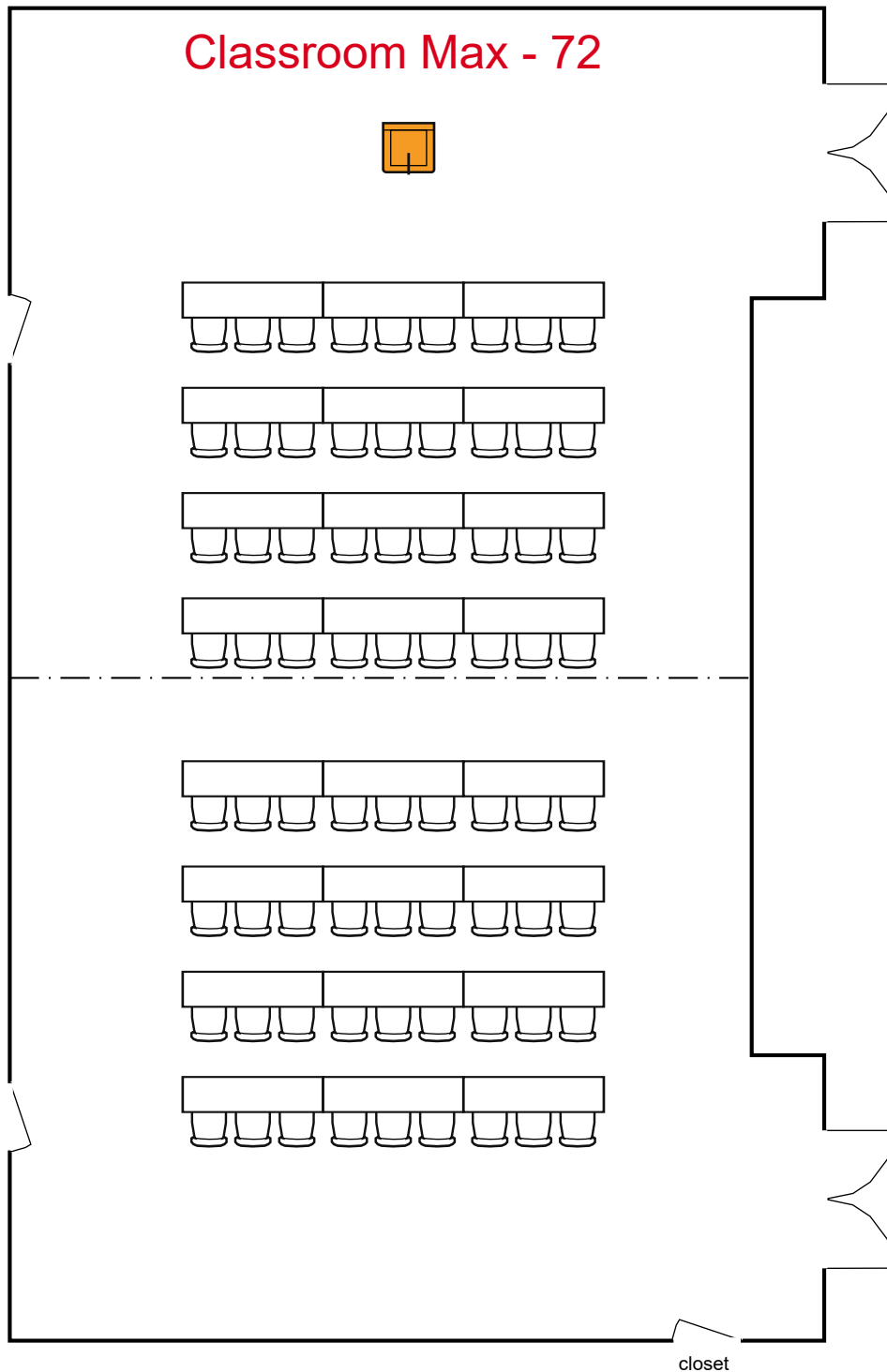

Room Plan Name: Forum H-I - Classroom

72 seats 24 tables
0 booths

Forum I
Forum H

U-Shape Max - 36

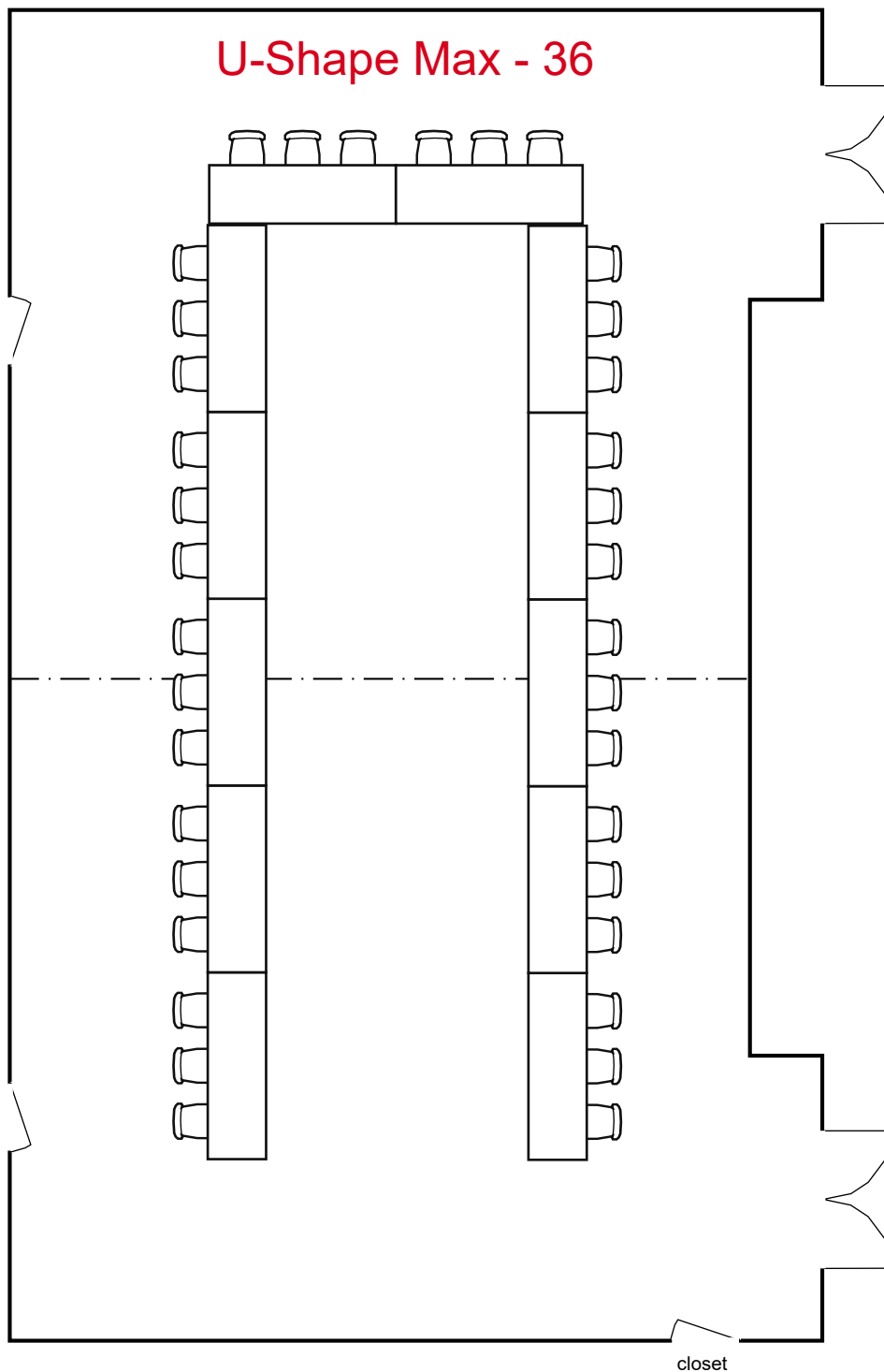

Room Plan Name: Forum H-I - U-Shape

36 seats 12 tables
0 booths

Forum I
Forum H

Banquet Max - 80

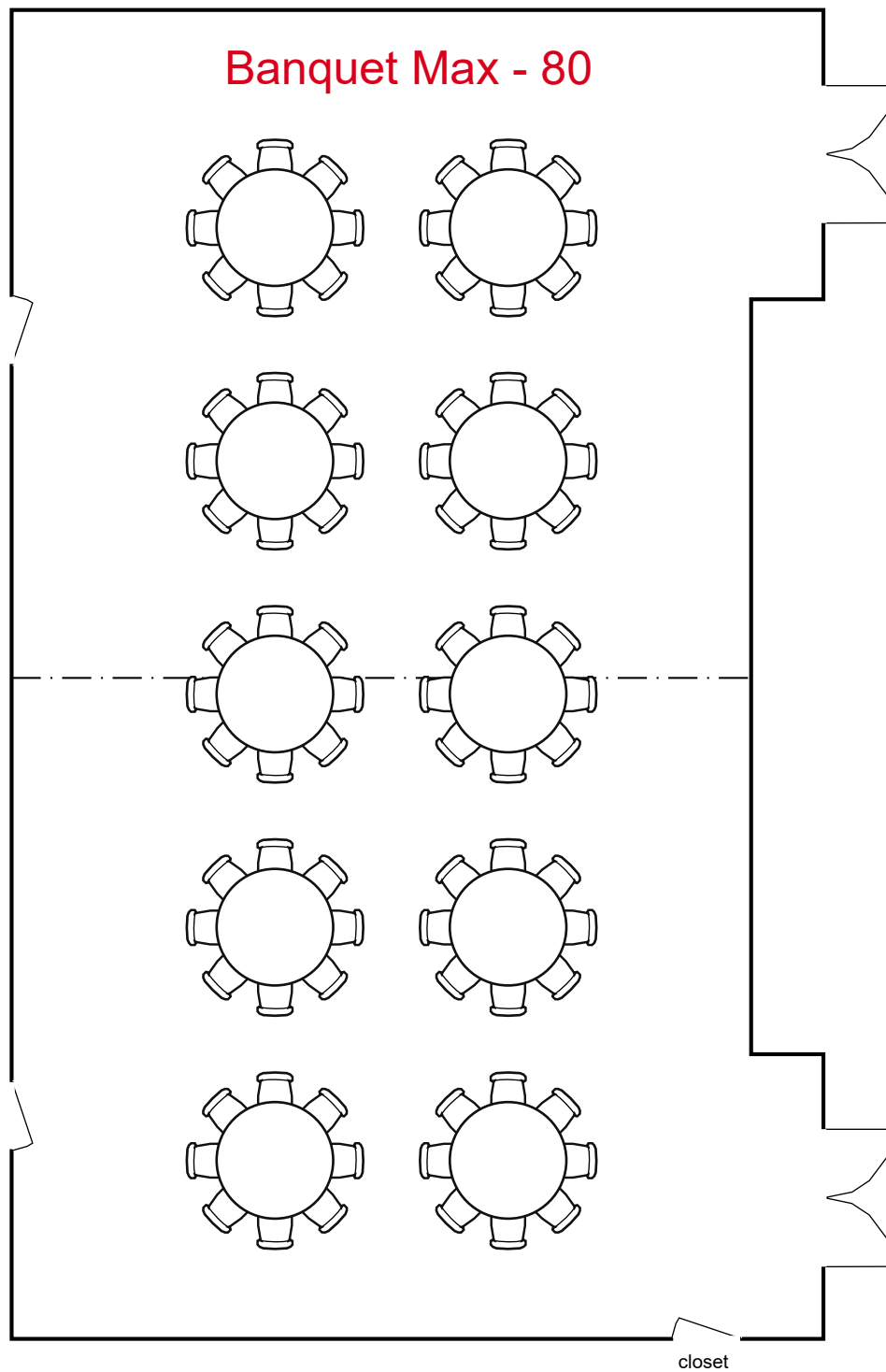

Room Plan Name: Forum H-I - Banquet

80 seats 10 tables
0 booths

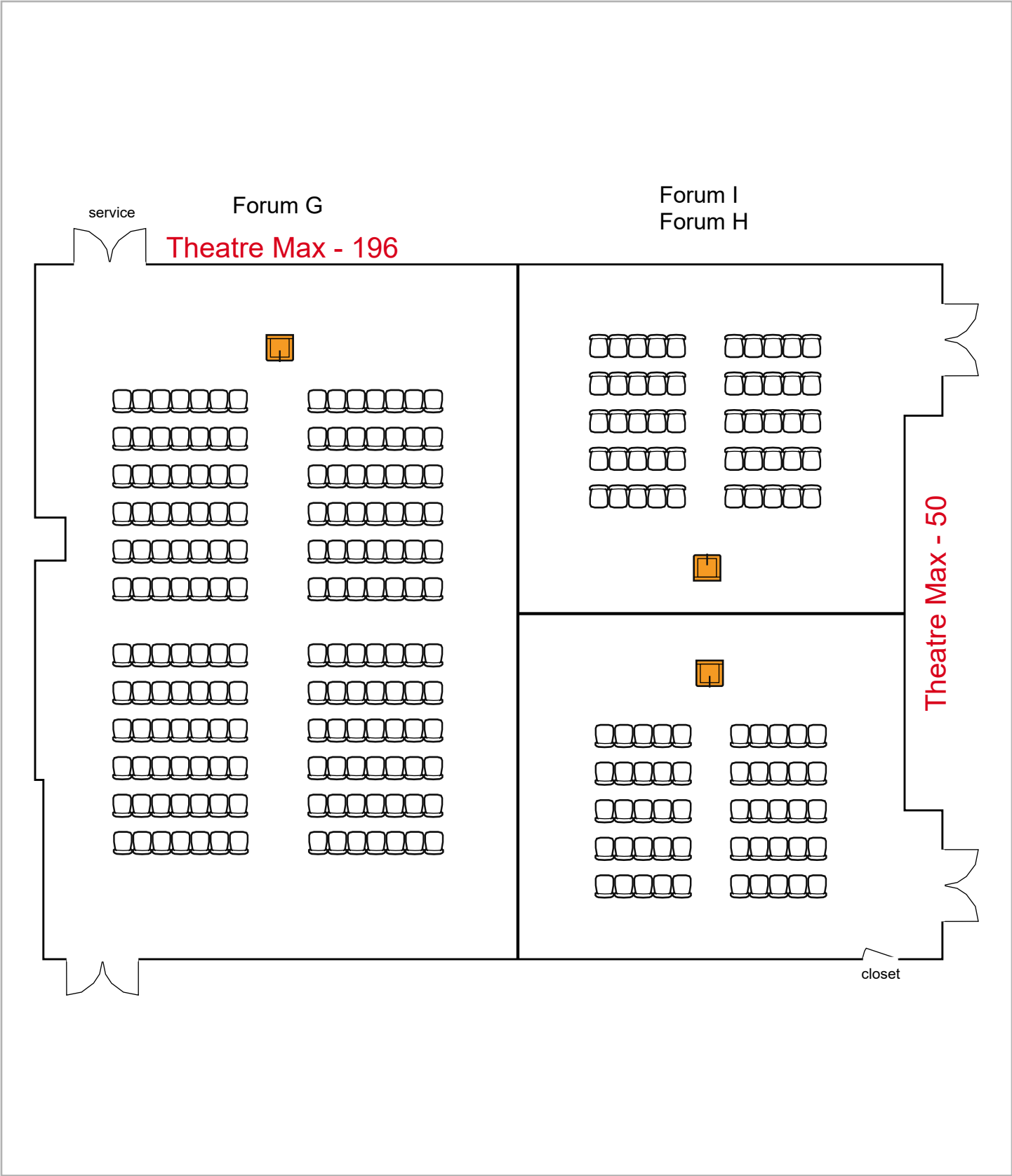

Room Plan Name: Forum GHI - Theatre

268 seats 0 tables
0 booths

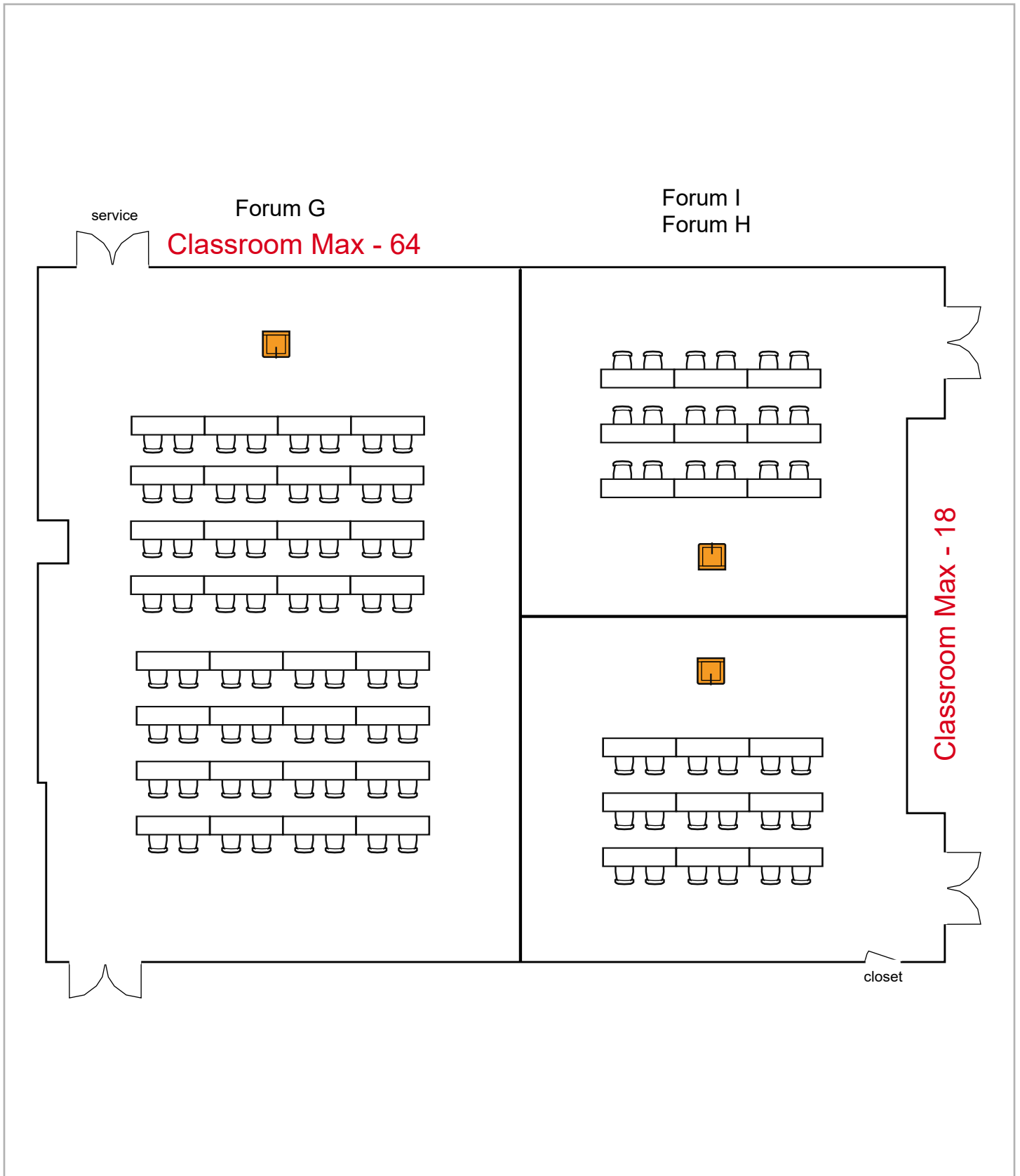

Room Plan Name: Forum GHI - Classroom

100 seats 50 tables
0 booths

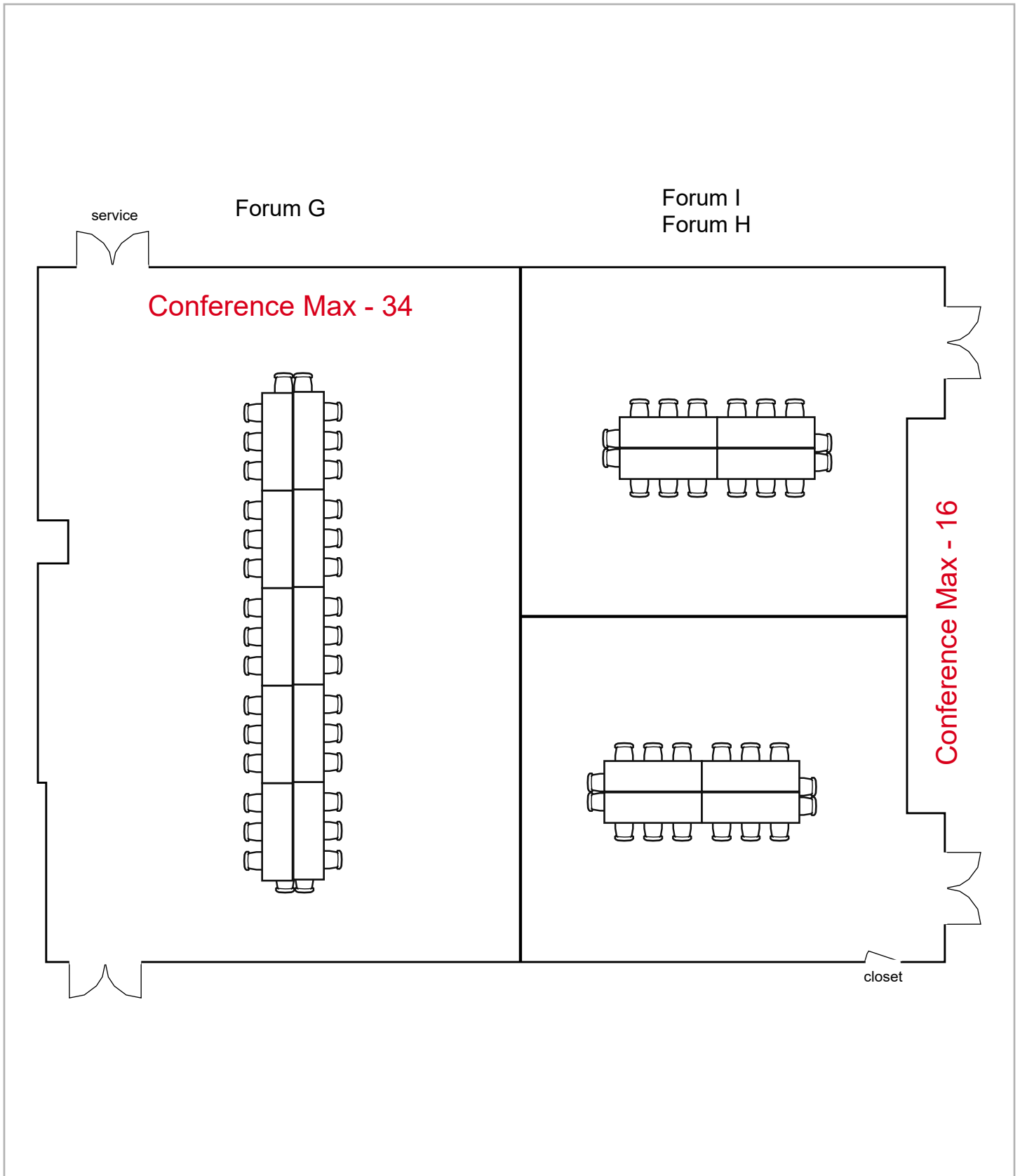

66 seats 18 tables
0 booths

Room Plan Name: Forum GHI - Conference

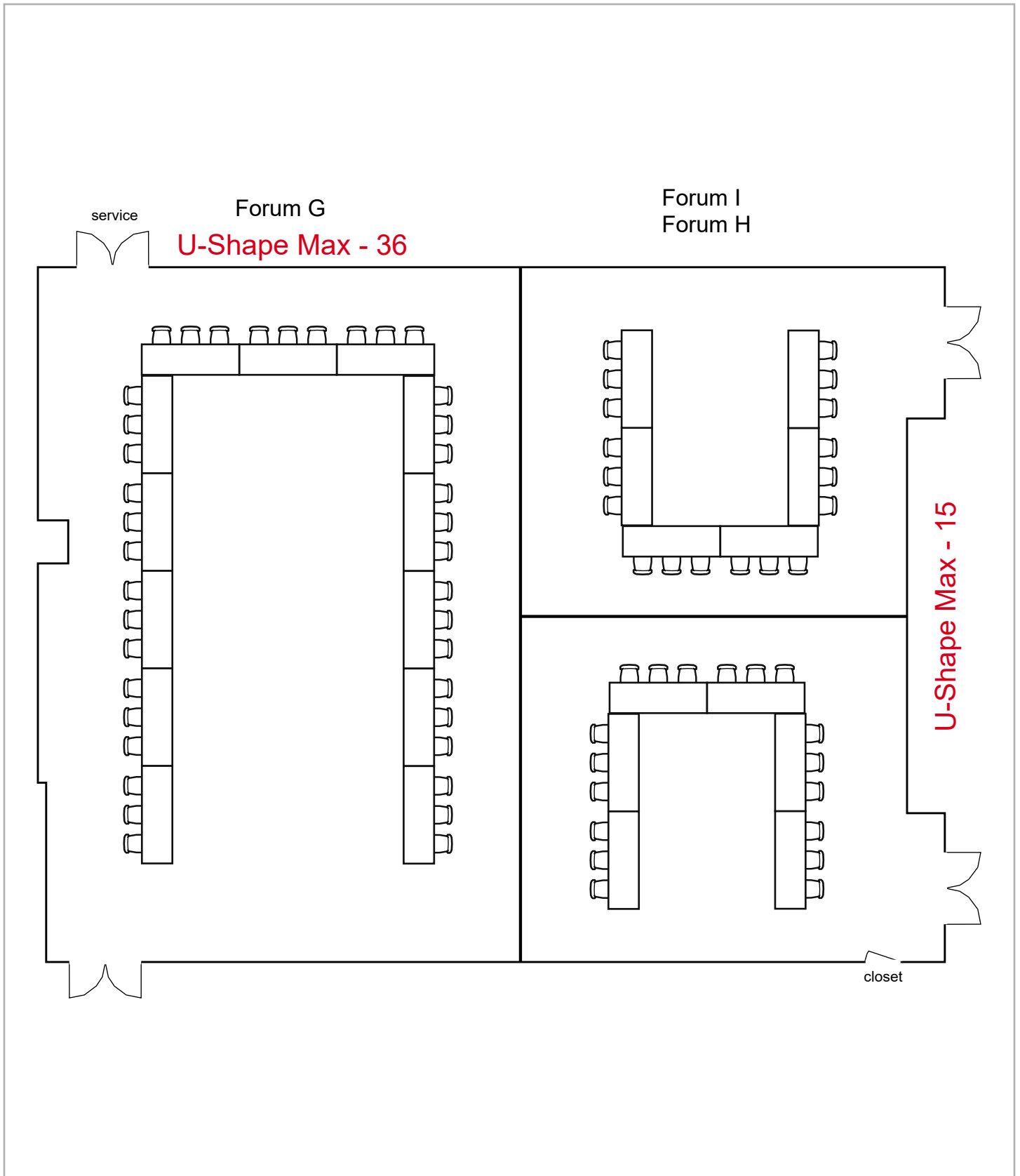

Room Plan Name: Forum GHO - U-Shape

75 seats 25 tables
0 booths

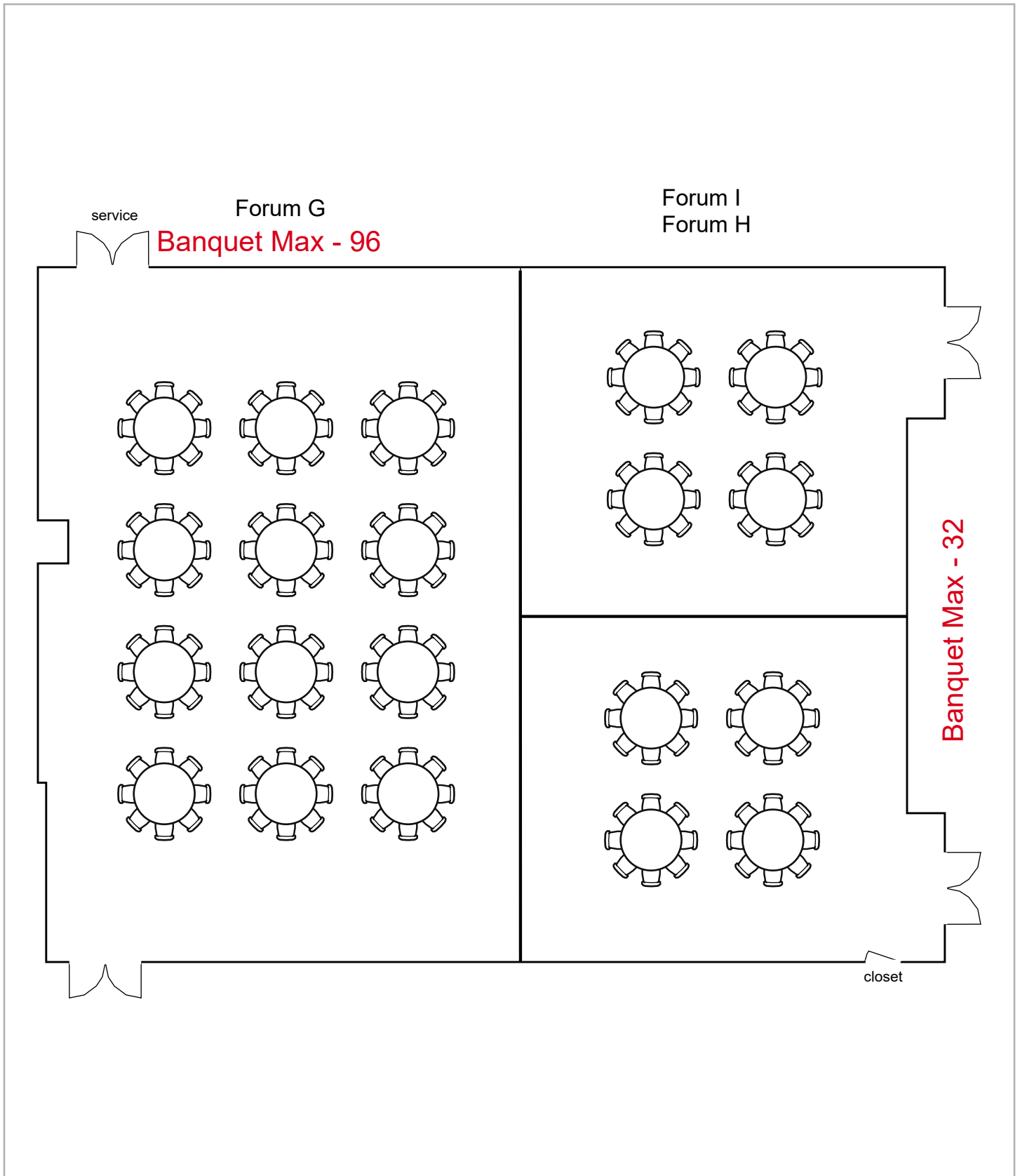

Room Plan Name: Forum GHI - Banquet

160 seats 20 tables
0 booths

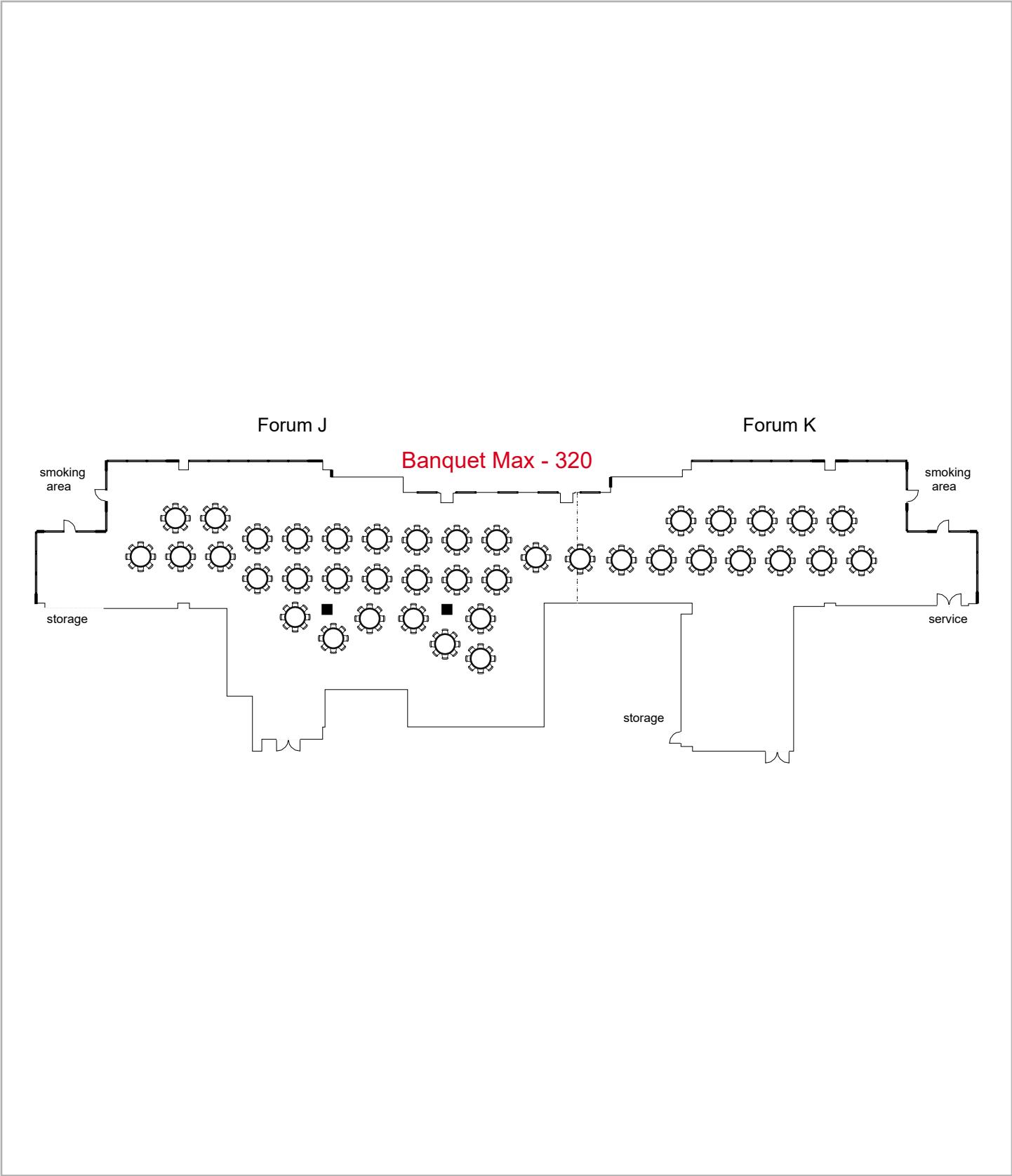

Room Plan Name: Forum J-K - Banquet

320 seats 40 tables
0 booths

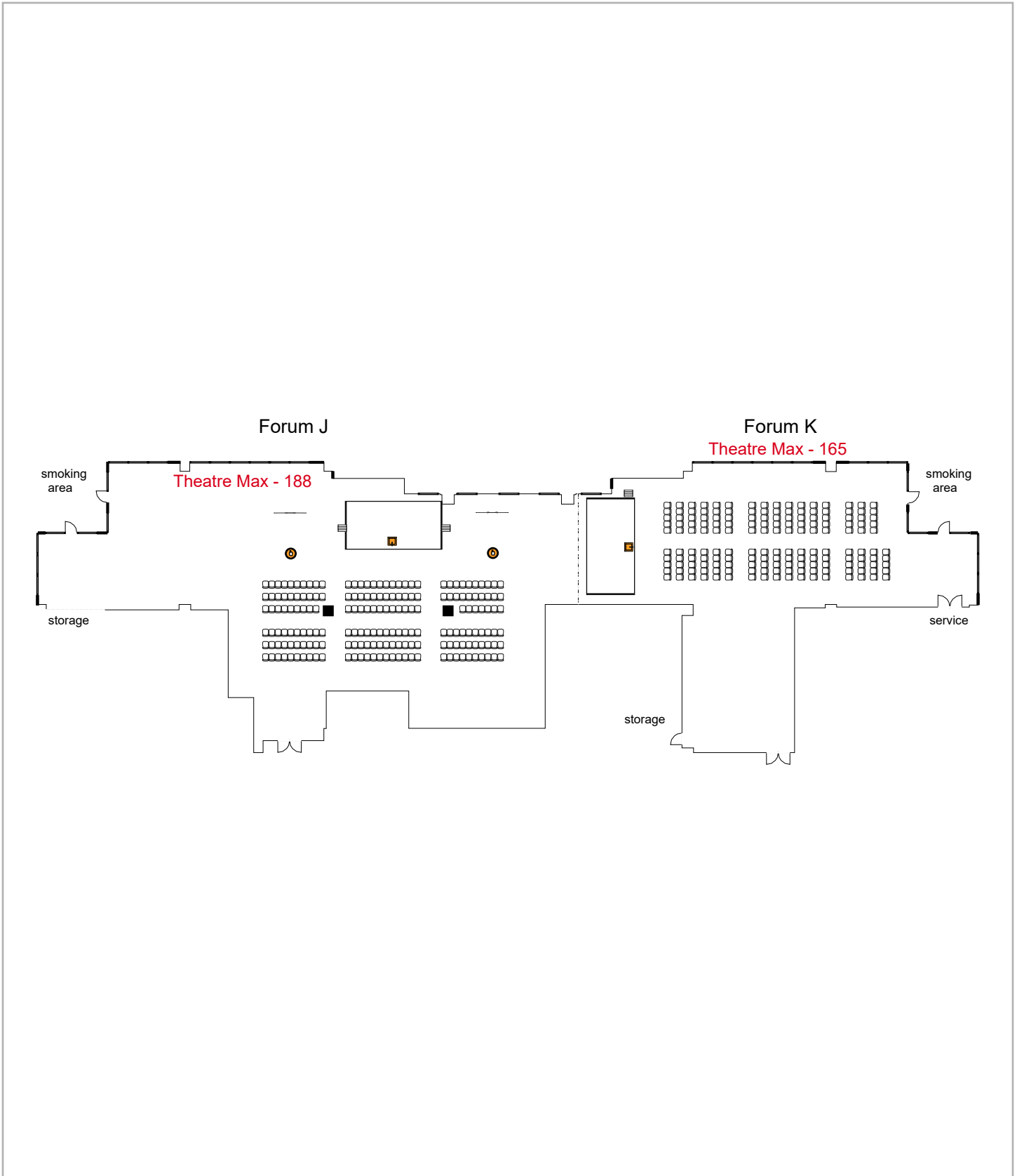

Room Plan Name: Forum JK - Theatre

353 seats 2 tables
0 booths

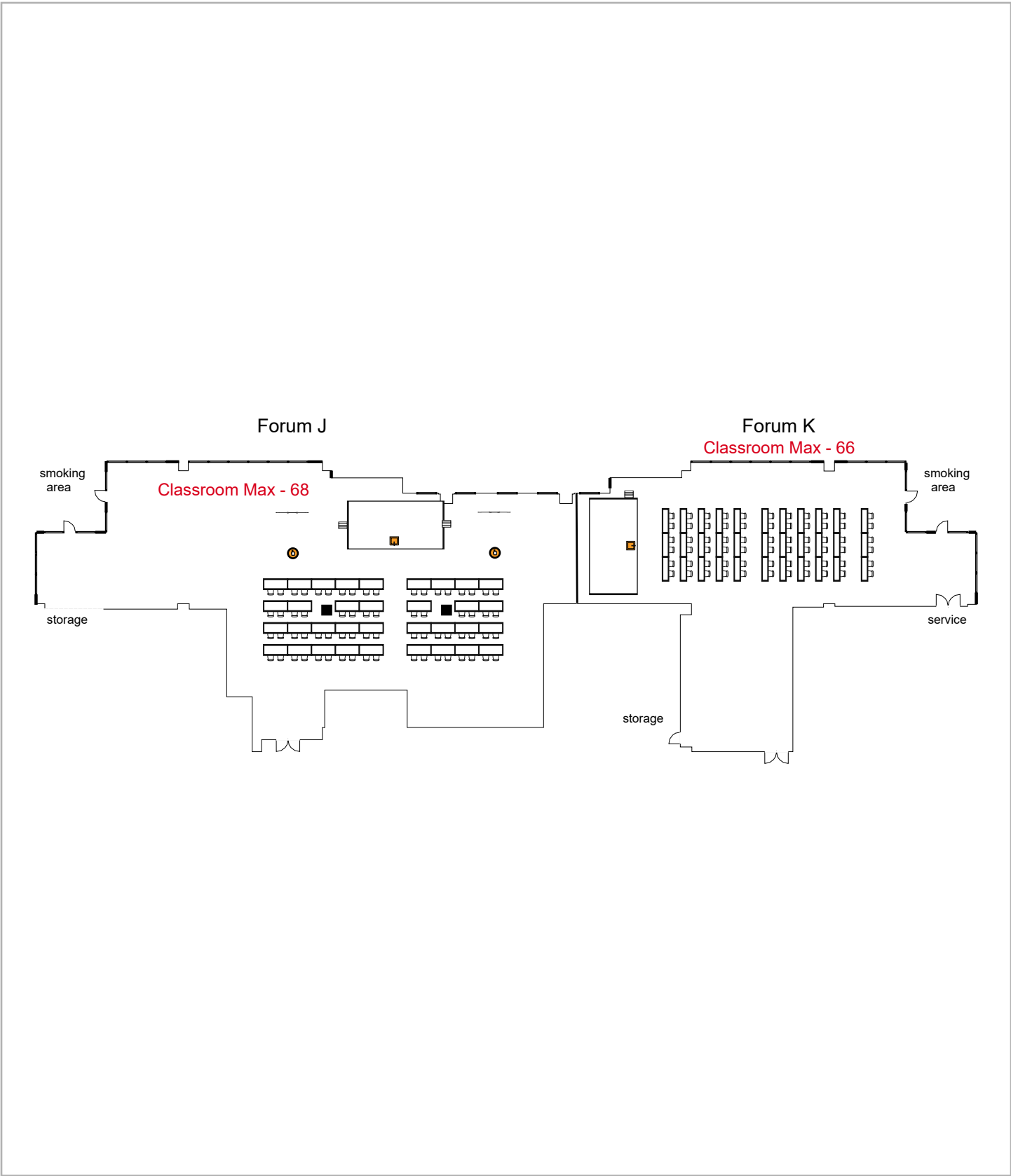

Room Plan Name: Forum JK - Classroom

134 seats 69 tables
0 booths

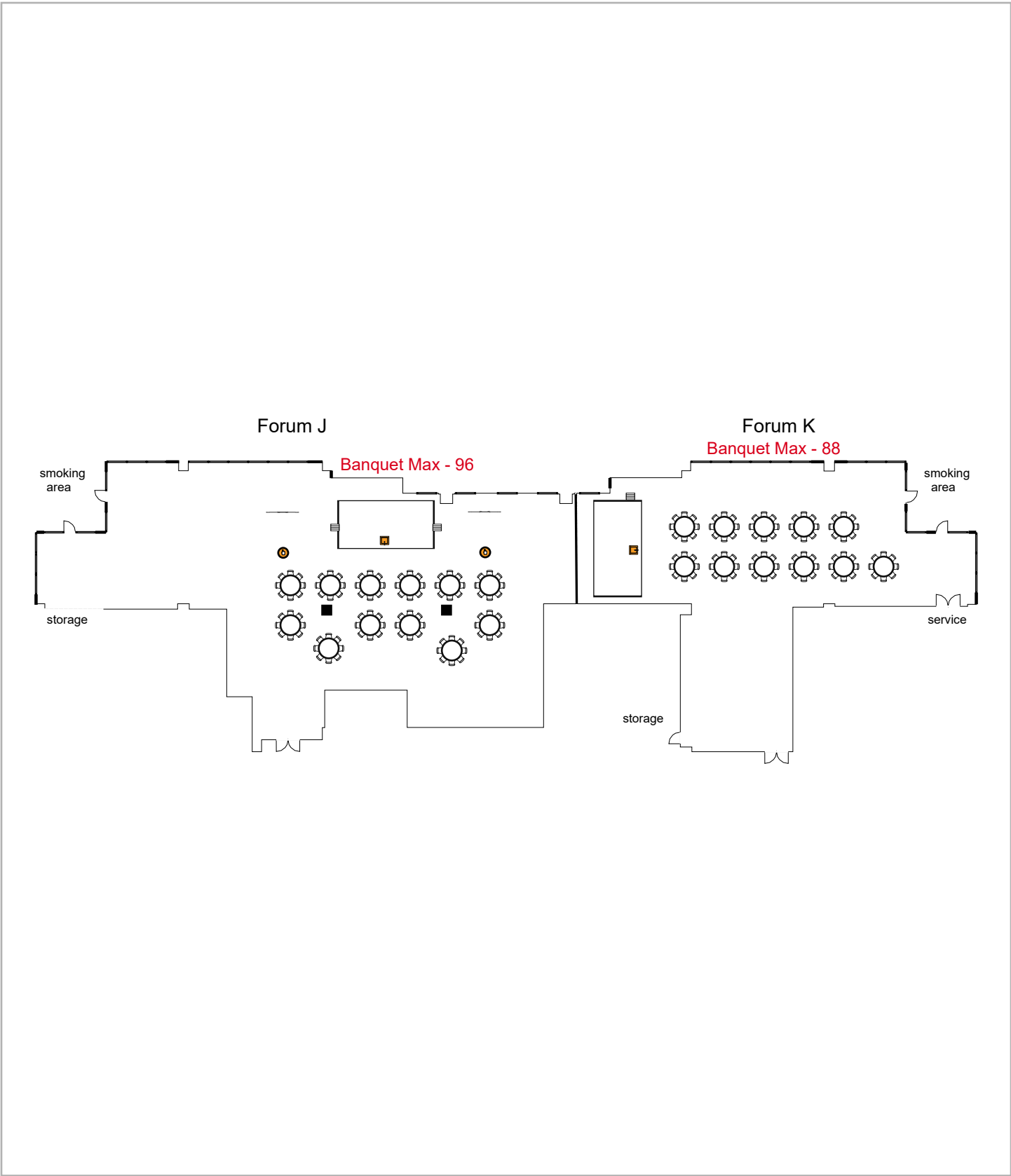

Room Plan Name: Forum JK - Banquet

184 seats 25 tables
0 booths

Forum L

Conference Max - 16

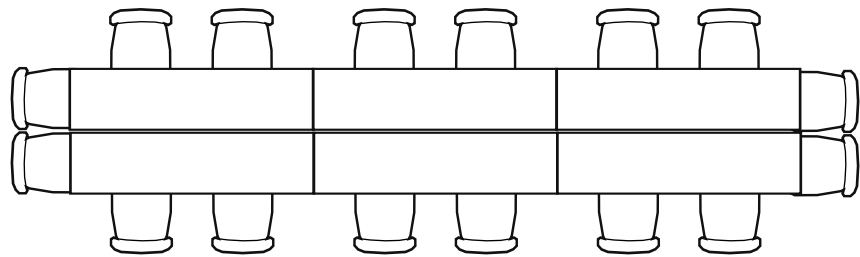

storage

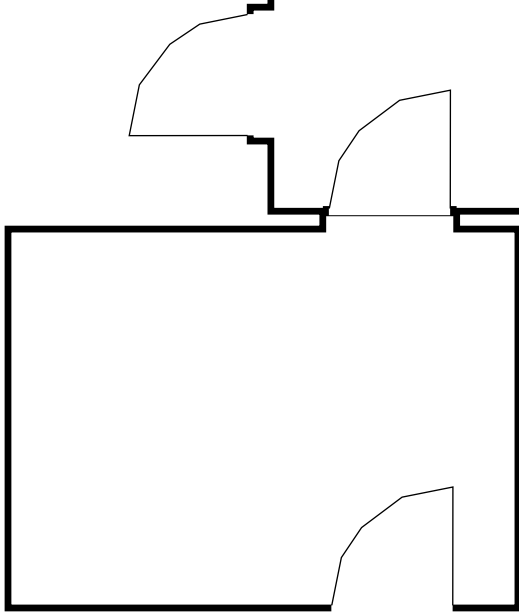

Room Plan Name: Forum L - Conference

16 seats 6 tables
0 booths

Forum L Theatre Max - 31

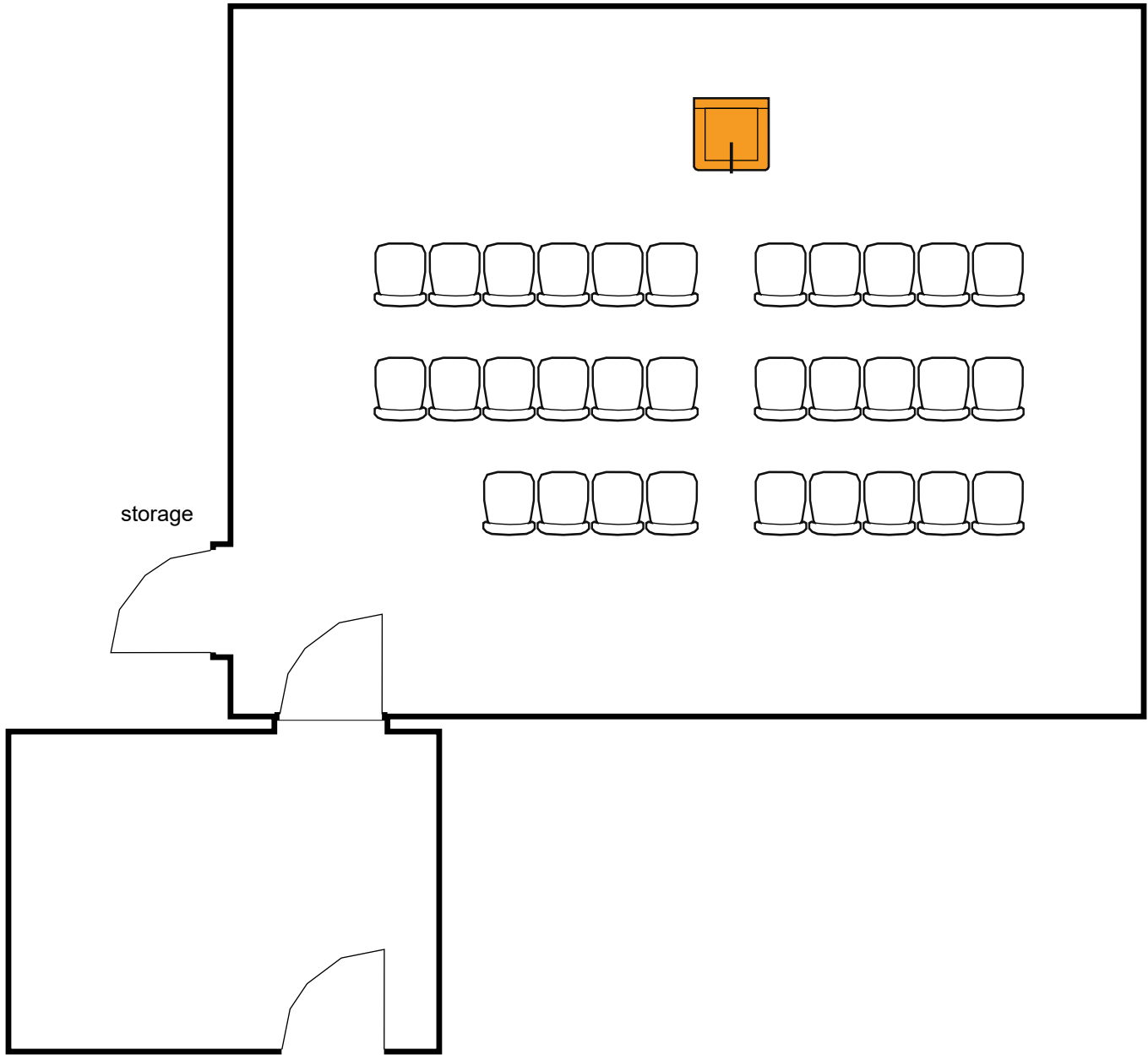

Room Plan Name: Forum L - Theatre

31 seats 0 tables
0 booths

Forum L

Classroom Max - 12

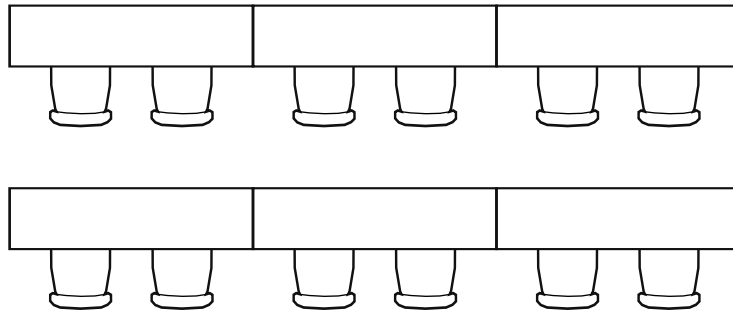

storage

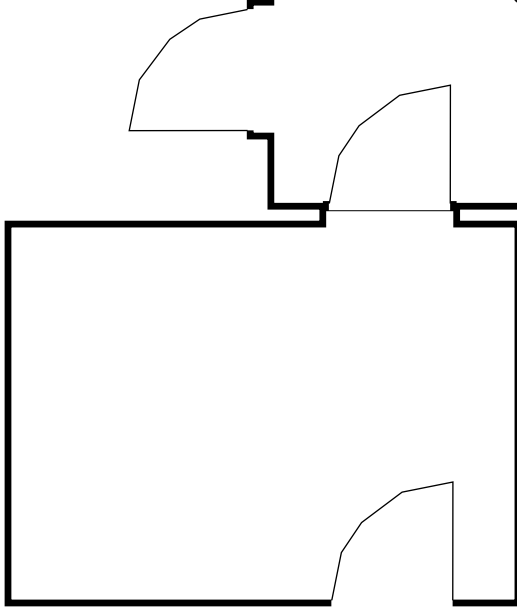

Room Plan Name: Forum L - Classroom

12 seats 6 tables
0 booths

Forum L

U-Shape Max - 15

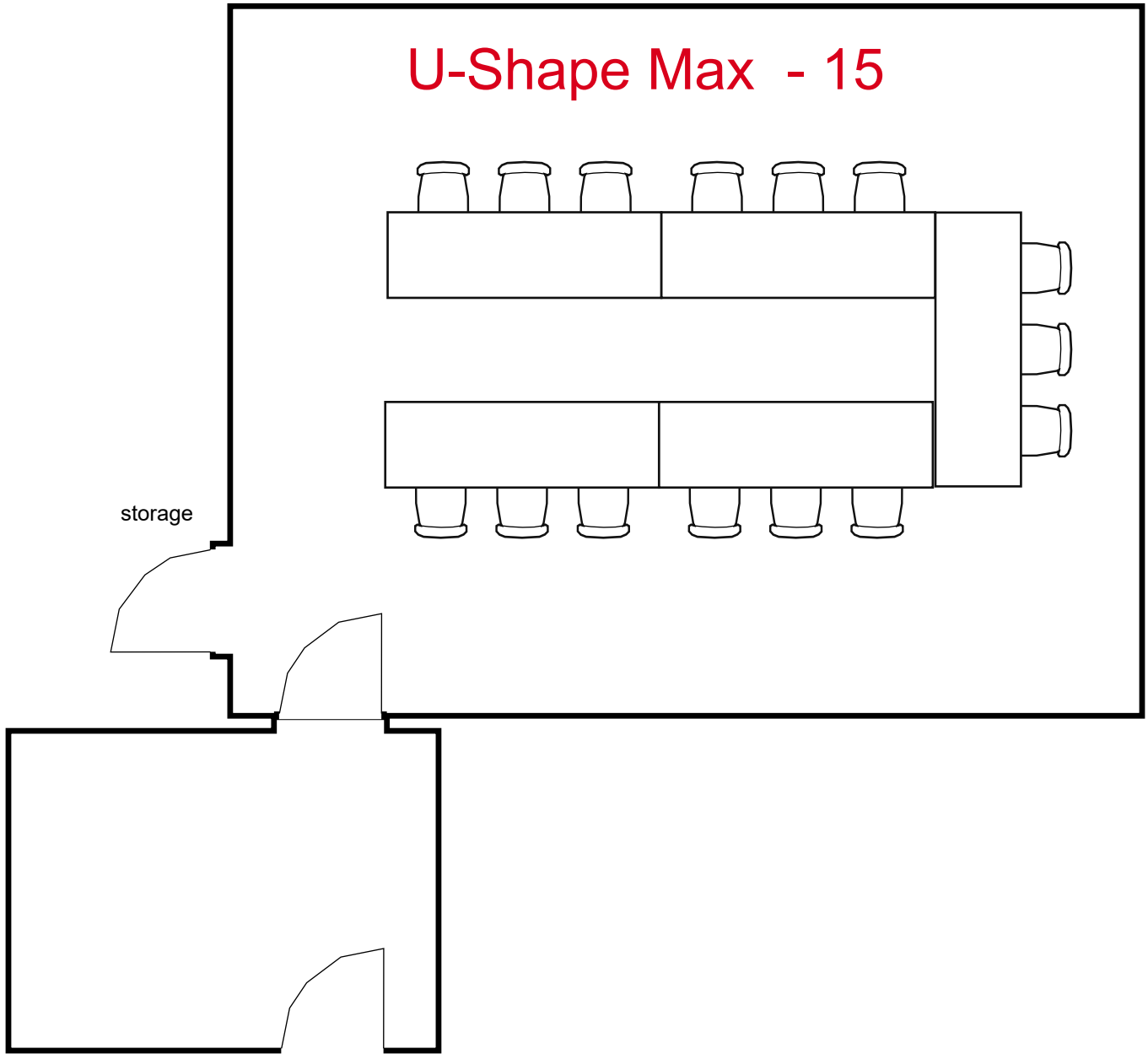

Room Plan Name: Forum L - U-Shape

15 seats 5 tables
0 booths

Forum L **Banquet Max - 24**

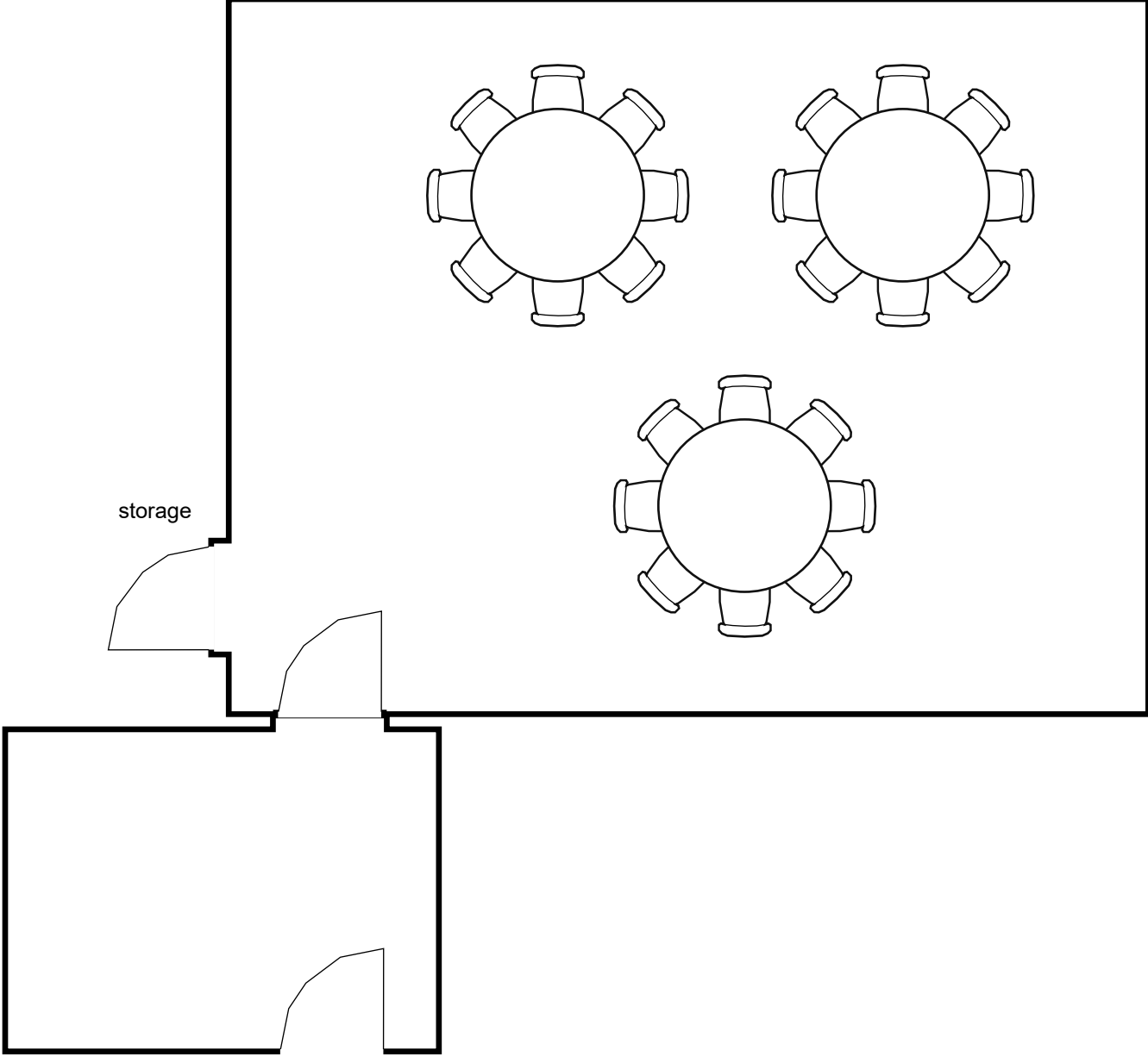

Room Plan Name: Forum L - Banquet

24 seats 3 tables
0 booths